

DC MOTORS



Compact DC Motors

Japan Servo's DC Miniature Motors are widely used in a variety of application fields, from copiers and other office equipment, to remote-controlled equipment, medical equipment, vending machines, and game machines.

These motors may be combined with Japan Servo's full line of gearheads to meet a wide range of torque and output speed specifications.

Japan Servo provides a practical and economic choice as drive actuators. Strict quality control ensure reliable performance as well as prompt delivery at reasonable price. Japan Servo provides a full variation line-up of stock model and customized design motors to best meet your specific application needs.





DMN Series

Long life

High quality

High output

Low noise

RoHS-compliant



Features

- **Long-life:**
*Intermittent operation over 1 million cycles with optimized brush design^{*1}*
- **Continuous operating life of 3000 hours^{*1}**
- **High output:** *High heat dissipation and heat resistance achieves higher output*
- **High strength:** *High radial load capacity due to robust construction, large diameter output shaft and ball bearings*
- **Low noise and increased insulation due to new resin brush holders**
- **Large selection of gear heads and reduction ratios are available to meet all needs**
- **Also available with magnetic revolution sensor and noise filter^{*2}**

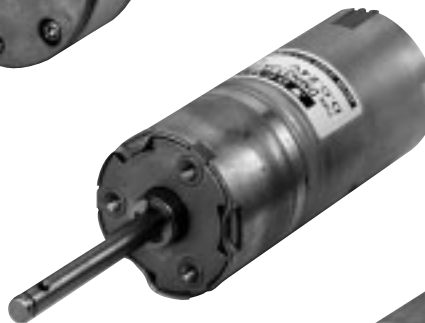

^{*1} Differs depending on environment and application. Contact us for details. ^{*2} Scheduled for release

Long Life

Life time

DME Series	DME25	DME33	DME34	DME37	DME44
	1000Hours			2000Hours	
DMN Series	DMN29			DMN37	
	3000Hours			3000Hours	

Continuous Operation :

※The motor life-time is dependent upon actual application conditions. Please consult us for more information.

Brush Wear Rate

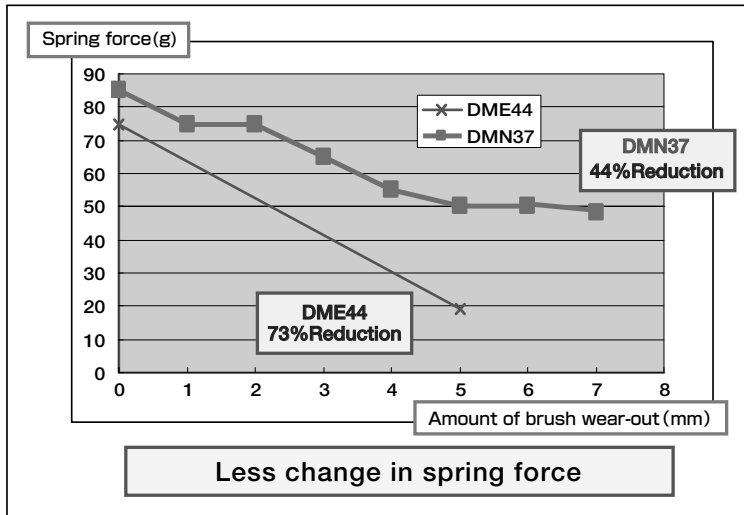

Brush Length

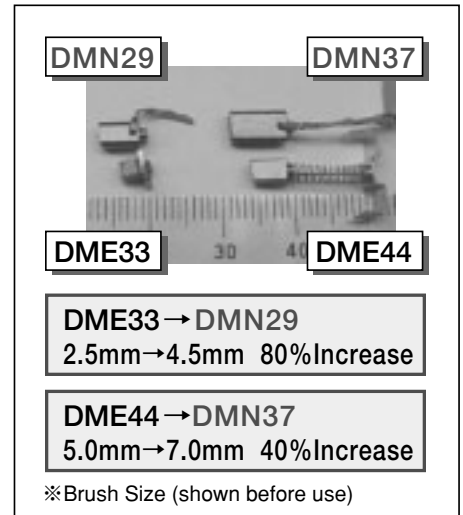

Comparison of Noise

DME25/33/34 ⇨ DMN29

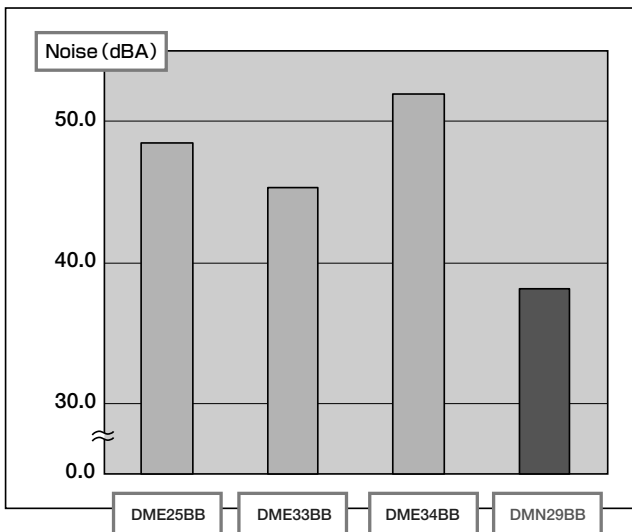

By adoption of Resin Brush Holder, Noise reduced by 8dB compared to DME25, 33, 34

DME37 ⇨ DMN37

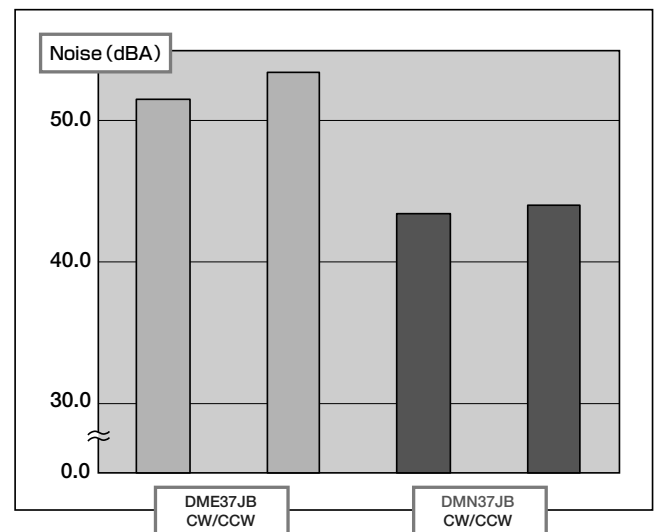

By adoption of Resin Brush Holder, Noise reduced by 8dB compared to DME37

DMN29



● DIMENSIONS Unit mm(inch)

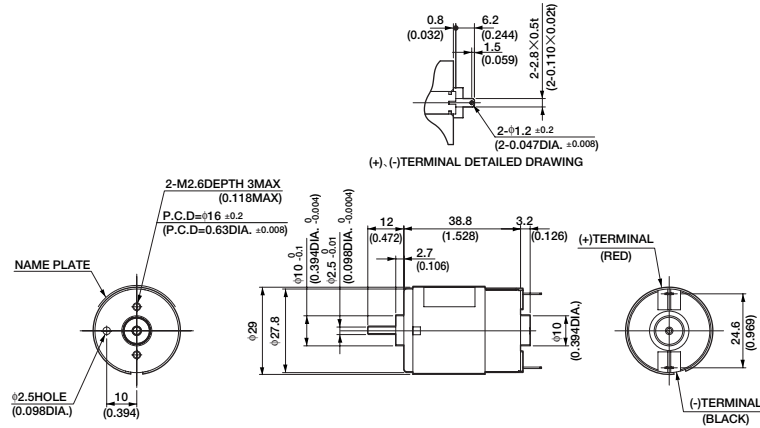

● CURRENT, SPEED-TORQUE CURVE

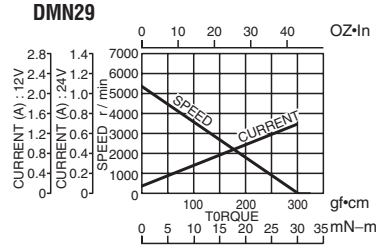

● CONNECTION

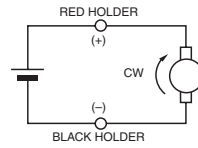

● STANDARD SPECIFICATIONS

Model	Rated					No load		Stall torque		Weight		
	Output W	Voltage V	Torque		Current A	Speed r/min	Current A	Speed r/min	mN-m	oz-in	g	lb
			mN-m	oz-in								
DMN29BA	3.0	12	7.8	1.11	0.42	3700	0.07	5000	30	4.17	90	0.20
DMN29BB	3.0	24	7.8	1.11	0.21	3700	0.05	5000	30	4.17	90	0.20

DMN37



● DIMENSIONS Unit mm(inch)

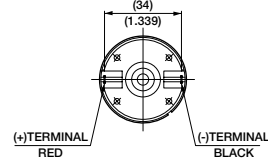
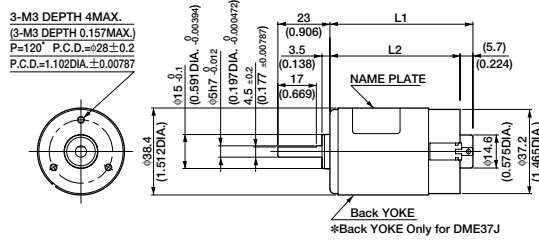
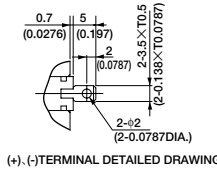

MODEL CODE	VOLTAGE	OUTPUT	CURRENT
SA	12V	4.6W	0.78A
SB	24V	4.6W	0.37A
BA	12V	7.2W	1.01A
BB	24V	7.2W	0.53A
KA	12V	9.2W	1.20A
KB	24V	9.2W	0.60A
JB	24V	14.7W	0.94A

Model	L1		L2	
	(mm)	(inch)	(mm)	(inch)
DMN37S	45.2	1.780	39.5	1.555
DMN37B	53.2	2.094	47.5	1.870
DMN37K	58.2	2.291	52.5	2.067
DMN37J	63.2	2.488	57.5	2.264

● CURRENT, SPEED-TORQUE CURVE

DMN37SA, DMN37SB

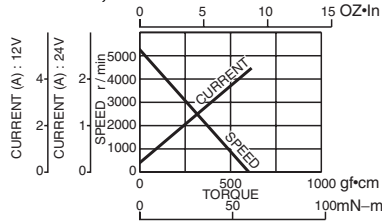

DMN37BA, DMN37BB

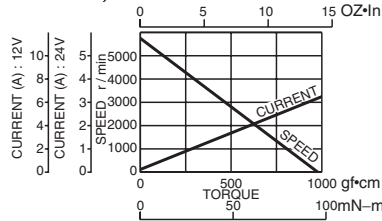

DMN37KA, DMN37KB

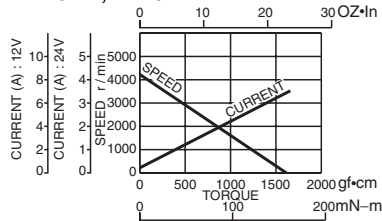

DMN37JB

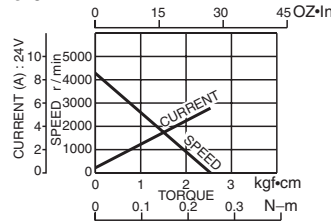

● CONNECTION

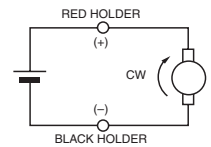

● STANDARD SPECIFICATIONS

Model	Rated						No load		Stall torque		Weight	
	Output W	Voltage V	Torque		Current A	Speed r/min	Current A	Speed r/min	mN·m	oz·in	g	
			mN·m	oz·in							g	lb
DMN37SA	4.6	12	9.8	1.39	0.78	4500	0.26	5500	54	7.64	130	0.29
DMN37SB	4.6	24	9.8	1.39	0.37	4500	0.12	5500	54	7.64	130	0.29
DMN37BA	7.2	12	14.7	2.08	1.01	4700	0.25	5500	98	13.89	180	0.40
DMN37BB	7.2	24	14.7	2.08	0.53	4700	0.13	5500	98	13.89	180	0.40
DMN37KA	9.2	12	24.5	3.47	1.20	3600	0.27	4300	160	23.61	210	0.46
DMN37KB	9.2	24	24.5	3.47	0.60	3600	0.14	4300	160	23.61	210	0.46
DMN37JB	14.7	24	39.2	5.55	0.94	3600	0.16	4300	240	34.72	240	0.53

*Intermittent ratings are given for DMN37JB. (Duty 50%)

Structure

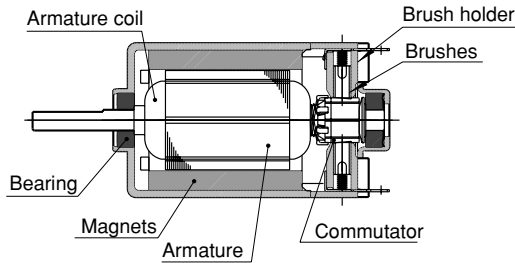

Fig. 1

• Brushes

The brush is an important part that serves as a commutating mechanism. The brush's service life (in accordance with wear) will be the service life of the direct-current motor.

• Commutator

In general, copper is the material used, but to counteract how it softens at high temperatures, a small amount of silver is mixed with it.

• Armature coil

In general, electric wire known as magnet wire is used. Wire diameter is selected in accordance with the motor's specifications, and the wire is connected to the commutator bar by means of welding, soldering or other such methods.

• Armature

For the armature, magnetic steel sheet is used to increase magnetic flux density.

• Magnets

Broadly speaking, the magnets used in the motor can be classified in terms of whether they are ferrite, alnico, rare earth, etc. Magnets are selected in accordance with usage purpose, based on their features.

• Bearing

There are ball bearings and sleeve bearings, and they are used in accordance with purpose.

The ball bearing is the type that is appropriate for uses involving large bending loads.

Current and rotating torque characteristics

The magnet DC motor has dropping characteristics (rotation speed) and rising characteristics, as shown in Figure 2. When applied voltage V is changed, as shown in Figure 2, torque rotating speed characteristics will be proportional to the value for V , but current torque characteristics will only change very slightly. (For details, please refer to the relational expression for current and torque rotating speed.)

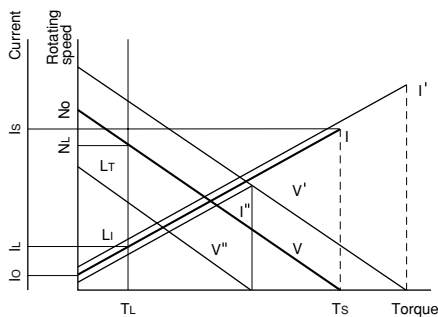

Fig. 2

How to view characteristics

As shown in Figure 2, at applied voltage V , when load torque T_L is added to the motor, rotating speed and current will be N_L and I_L , respectively. When V has been changed to $V'V''$, the result can be similarly sought. No-load rotating speed, N_0 , and stalling (starting) torque, T_s , will be proportional to the applied voltage; thus, the values for when a 24V motor, for example, is used at 20V

or 18V will be on the order of those shown in Table 1. (No-load current I_0 will be sufficiently small compared with the stalling current and can thus be disregarded.) When changing the rated voltage substantially (from 24V to 6V, for example), it will be necessary to depend on actual measurement.

However, use at something other than the rated voltage could cause abnormal brush wear and startup malfunctions. Thus, we ask that you confirm the usage conditions.

Voltage	No-load rotating speed No	Stalling torque Ts	Stalling current Is
24V	5000r/min	40mN·m	1.0A
20V	$\frac{20}{24} \times 5000$ 4166	$\frac{20}{24} \times 40$ 33	$\frac{20}{24} \times 1$ 0.83
18V	$\frac{18}{24} \times 5000$ 3750	$\frac{18}{24} \times 40$ 30	$\frac{18}{24} \times 1$ 0.75

Table 1

Explanation of Terminology

Term/Symbol	Content
No-load rotating speed No	Rotating speed with no load
No-load current I_0	Input current with no load
Stalling torque T_s	Max. value for motor-generated torque. In general, a DC motor's stalling torque is equal to its starting torque.
Load torque T_L	As shown in Figure 3, when a pulley with radius R is attached to the motor and force of F is applied to the pulley's circumference, the torque generated, T_L , can be derived by multiplying F and R ($F \times R = T_L$).  Note : Using the lock with voltage applied could cause burnout.

Fig. 3

Relational expressions for torque, rotating speed and current

Relational expressions are as follows.

If the no-load rotating speed from formula 1 is taken to be N_0 , when load torque T_L is zero, there will be no load; thus, if $T_L = 0$, the following will be the case.

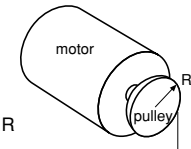
No-load rotating speed N_0 will be determined from the size of the motor's friction torque, T_0 . If T_0 is low, the no-load rotating speed from formula 3 will be roughly proportional to the applied voltage. In addition, stalling (starting) torque will equal the load torque when rotating speed N from formula 1 is zero, resulting in the following:

Starting torque will be roughly proportional to the applied voltage. Current will be as follows.

From this formula, when load torque T_L and friction torque are constant, the current will be constant with no relation to applied voltage. The no-load current will be the value that makes the load torque zero in formula 5, but friction torque T_0 will change slightly, in accordance with rotating speed; thus, there will be some change caused by the applied voltage.

If motor output is designated as P (W), torque as T (N·m) and rotating speed as N (r/min), motor output P (W) will be as follows.

$$P = 0.105 \times T \times N \dots \dots \dots \text{Formula 6}$$

N : Rotating speed

T_0 : Motor's friction torque

V : Applied voltage

T_L : Load torque

r : Armature-circuit resistance

K_1 and K_2 : Motor-specific constant

Technical Description:

Operating Precautions

DC motors are compact and display high output, and their speed is easy to control. They may be driven by battery or any other power supply and are therefore also easy to use. However, inappropriate power supply may lead to burnout or abnormal brush wear.

Problems with power supply, installation, and general precautions and problems with a motor installed in-circuit will be described.

• Overload and lock-up

An excessive amount of load torque is applied during overloaded driving or when locked up, causing an excessive current flow with heat damage being incurred by the motor. Therefore, overloaded or locked-up use is to be avoided. (Locking up for 5 or more seconds results in damage to a motor. Do not lock up a motor for 5 or more seconds.)

• Applied voltage

Be sure to use a motor at its rated voltage ($+U_N$), and avoid any surge voltage. We can specially manufacture motors designed with an electrical path protecting the motor from surges and reversed polarity. Please contact us for details.

• Applying non-rated supply voltages

Applying a voltage higher than the motor's rating results in a temperature increase, leading to heat damage or lowered service life. Scoring of the commutator surface by sparks and mechanical brush wear arising from vibration may also occur.

Applying a voltage lower than the motor's rating may eventually result in the motor failing to start. This is due to the build up of carbon powder on the commutator.

Motors are manufactured for use within $\pm 10\%$ of their rated specifications.

Please contact us if you need to use motors outside their ratings.

• Brush wear promoted by power supply ripples

Brush wear may be mechanical wear due to brush and commutator abrasion or electrical wear due to sparking between the brush and commutator, the latter being the most common. Brush wear is therefore greatly affected by ripples in the power supply voltage, and use of general regulated DC is recommended. However, when rectifying AC for use by a motor, be sure to use full-wave rectification with a capacitor or similar element in a smoothing circuit.

• Ambient conditions

The service life of a DC motor is dependant upon its rectifying action. Care must be taken to ensure good commutation, as dust, oil, gas, water, etc. Water, etc, on the commutator surface results in poor rectification and increases brush wear.

• Changing the brush position

The brushes are generally fixed in position such that rotational speed and current characteristics are maintained equivalent in both clockwise and counter-clockwise directions. These are basically determined based on the position of the magnetic poles. Rotating the motor after not carefully relocating parts such as the brush holder (for fixing the brushes) or rear cover results in misalignment of the brushes and magnets. This will produce change in the above characteristics in the rotational direction or cause poor rectification, leading to abnormal brush wear. Therefore, changing of the brush positioning is to be avoided.

• Installed orientation

Motors are generally designed for use with a horizontal output shaft. Special consideration must be given to components including bearings and grease washers when intended for an upward- or downward-facing output shaft. Please contact us for details.

Further, avoid installing a motor in a manner in which grease from the gear head would tend to enter the motor (e.g., with an upward-facing output shaft).

• Noise generation

Electrical noise is generated as a result of sparks from commutation between the brushes and commutator. Please contact us for assistance with lowering noise.

• Gear heads for intermittent drive

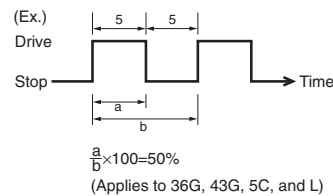

Fig. 5

The gearhead is assembled with a fixed shaft about which a gear revolves and transmits power. It is not suited to continuous drive. You should maintain the duty ratio between ON and OFF states at no more than 50%, with the maximum ON state not exceeding 5 seconds.

• Motor and gear head combination

When combining a gear head with a pinion shaft, gently fit the gear head on turning it right and left, being careful that the pinion and the gear in the gear head do not strongly clash with each other.

Using force will cause noise-producing scratches in the pinion and the gear. Scratches are Failures by a decreased service life and are the cause of unforeseen accidents.

• Load variation

Even with torque below the rated load, a motor will incur more damage than might be imagined if there is frequent load variation. Exercise caution with operating conditions and load restrictions.

• Insulation resistance

The insulation resistance of a brush motor will naturally continue to decrease as its running time increases. The figures for resistance given in the catalog are for a new motor.

• Service life

Service life depends greatly on operating conditions and environment. Please contact us for details.

• Other aspects

Oil may seep out of the grease in the gear head depending on operating conditions, storage environment, etc.

This does not present any problems in the use of the gear head. However, contamination of the machine or equipment to which the geared motor is fitted may occur.

Motors with pulse generators:

There are two types of pulse generators that are featured in DME series motors : the magnetic and optical revolution sensor. (Note, the optical revolution sensor is available only in the DME34 model.) Both are incremental revolution sensor. And all the above generators can output Single Phase pulse signal only. When TWO Phase signal is required, contact our sales agent near you or directly to us. We may quote on case by case basis.



Magnetic Type



Optical Type

Magnetic Revolution Sensor :

Compared to the optical revolution sensor, the magnetic revolution sensor is more resistant to high temperatures, dust contaminations, vibrations and impact shocks. The design of the magnetic revolution sensor type motor is also more simple. In incremental type revolution sensor, pulse output signals are sent to a counter wherein the incremented value is displayed. Signal noise, here, lead to performance errors. Magnetic type revolution sensors are especially vulnerable to signal noise since the signal levels are usually very low (20mA to 30mA). Thus, make sure magnetic revolution sensor type motors are provided proper magnetic shielding, and signal lines are as short as possible (ideally within 5m).

●STANDARD SPECIFICATION OF REVOLUTION SENSOR

REVOLUTION SENSOR TYPE	MAGNETIC	OPTICAL
PULSE PER REVOLUTION	12P/rev.	24P/rev.
INPUT VOLTAGE	DC5V±10%	DC5V±10%
CURRENT CONSUMPTION	5mA nominal	25mA nominal
DUTY (B/A)	50±20%	50±10%

OUTPUT WAVEFORM (COMMON)

Optical Revolution Sensor:

Long-life LED is used as the light emitter, and a photo-transistor is used as the light detector. When using optical revolution sensor type motors, special considerations are needed to protect against dust and extreme temperatures. The most frequent causes of trouble in optical revolution sensors are : dust build-ups impairing proper optical properties ; and extreme leading to deterioration in light emission performance. Japan Servo can thus ensure full rated performance only in ambient temperatures between 0 to 40 degrees centigrade, and in dust-free conditions.

●CONNECTION

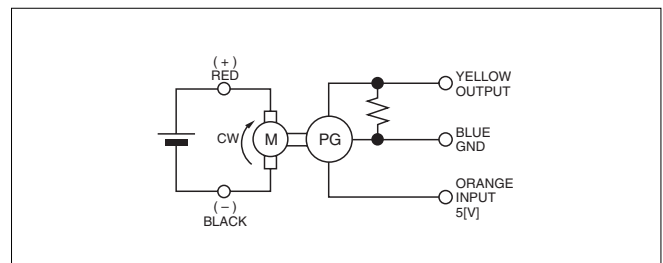

DC SMALL MOTORS **DME** Series

The DME Series motor is a feasible and practical DC motor that is used popularly in many applications.

According to user demands, Japan Servo combines the DME motor with a wide variation of high-performance gearboxes to further increase the application possibilities for the DME Series.

Also, in response to demands for a simple, low-cost motor that has a certain amount of controllability, Japan Servo provides DME models that feature pulse generators (magnetic or optical PG).

For certain models of the DME Series, the motor and gearboxes can be ordered separately, allowing for much greater versatility by combining various type motors with a wide range of reduction gears. Please refer to the product line-up chart to select the DME Series motor that is just right for your specific needs.





●DME SERIES MOTOR'S CONSTRUCTION AND CHARACTERISTICS.

MODEL	BRUSH HOLDING	CORE SLOTS	BEARING	MAGNET	LIFE* (hrs)	OUTPUT POWER (W)						PAGE		
						S	B	K	J	5	10		15	
DME 25	Holder	3 slots	Sintered sleeve bearing	Anisotropic	1000		○			◎3				12
DME 33	Spring plate	3 slots	Sintered sleeve bearing	Isotropic Anisotropic	1000	○				◎0.7				15
							○			◎3				
DME 34	Spring plate	3 slots	Sintered sleeve bearing	Isotropic Anisotropic	1000 (500)	○				◎1.3				21
							○			◎4.5				
DME 37	Holder	7 slots	Sintered sleeve bearing	Anisotropic	2000	○				◎4.6				29
							○			◎7.2				
								○		◎9.2				
									○			◎17.2		
DME 44	Holder	10 slots	Ball bearing	Anisotropic	2000	○				◎9.2			34	
							○				◎14.8			
DME 60	Holder	12 slots	Sint. sleeve/Ball bearing	Isotropic Anisotropic	2000	○					◎13		38	
							○					26◎		

FEATURE	BRUSH HOLDER		BEARING		MAGNET	
	Holder:Long-life (1000 hours only for DME25, due to its high-speed operation) Spring plate:Standard	2000hours 1000hours	Ball bearing	:Long-life	Anisotropic	:High output
		Sintered sleeve bearing	:Standard	Isotropic	:Standard	

*Operated in motor alone, and single direction.

●SELECTION CHART

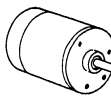
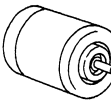
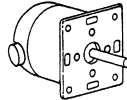
		MOTOR SPECIFICATION					MOTOR ONLY	MOTORS WITH SENSOR		GEARED MOTORS		
		OUTPUT POWER		RATED VOLTAGE		RATED CURRENT		MAGNETIC REVOLUTION SENSOR	OPTICAL REVOLUTION SENSOR	 36G	 43G	
		W	CODE	V	CODE	A						
DME25		3	B	12 24	A B	0.47 0.23	DME25BA DME25BB			DME25B36G <input type="checkbox"/> A DME25B36G <input type="checkbox"/> B	DME25B43G <input type="checkbox"/> A DME25B43G <input type="checkbox"/> B	
DME33		0.7	S	12 24	A B	0.12 0.06	DME33SA DME33SB	DME33SMA DME33SMB		DME33S36G <input type="checkbox"/> A DME33S36G <input type="checkbox"/> B	DME33S43G <input type="checkbox"/> A DME33S43G <input type="checkbox"/> B	
		3	B	12 24	A B	0.42 0.22	DME33BA DME33BB	DME33BMA DME33BMB		DME33B36G <input type="checkbox"/> A DME33B36G <input type="checkbox"/> B	DME33B43G <input type="checkbox"/> A DME33B43G <input type="checkbox"/> B	
DME34		1.3	S	12 24	A B	0.20 0.10	DME34SA DME34SB	DME34SMA DME34SMB	DME34SEA DME34SEB	DME34S36G <input type="checkbox"/> A DME34S36G <input type="checkbox"/> B	DME34S43G <input type="checkbox"/> A DME34S43G <input type="checkbox"/> B	
		4.5	B	12 24	A B	0.65 0.31	DME34BA DME34BB	DME34BMA DME34BMB	DME34BEA DME34BEB	DME34B36G <input type="checkbox"/> A DME34B36G <input type="checkbox"/> B	DME34B43G <input type="checkbox"/> A DME34B43G <input type="checkbox"/> B	
		7	K	24	B	0.41	DME34KB	DME34KMB	DME34KEB			
DME37		4.6	S	12 24	A B	0.78 0.37	DME37SA DME37SB	DME37SMA DME37SMB				
		7.2	B	12 24	A B	1.01 0.53	DME37BA DME37BB	DME37BMA DME37BMB				
		9.2	K	12 24	A B	1.20 0.60	DME37KA DME37KB	DME37KMA DME37KMB				
		17.2	J	24	B	1.07	DME37JB	DME37JMB				
DME44		9.2	S	12 24	A B	1.31 0.65	DME44SA DME44SB	DME44SMA DME44SMB				
		14.8	B	24	B	0.94	DME44BB	DME44BMB				
DME60		13	S	12 24	A B	2.07 1.00	DME60SA DME60SB					
		26	B	24	B	2.2	DME60BB					
								12	24			
							PULSES PER REVOLUTION					

●MOTOR DESIGNATIONS

[1] MOTORS ONLY

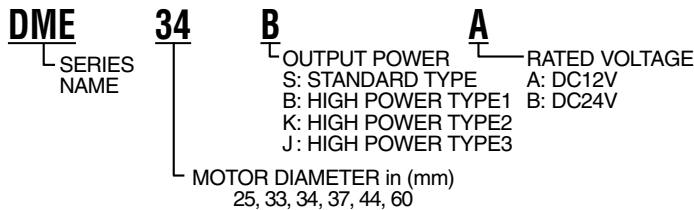

[2] MOTORS WITH SENSOR

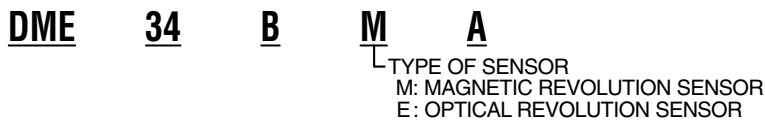

[3] GEARED MOTORS

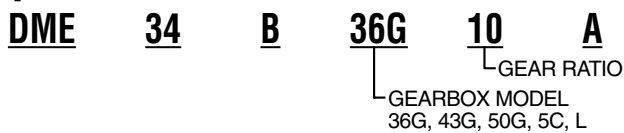



[4] MOTOR AND GEARBOX SUPPLIED SEPARATELY



PINION SHAFT	MATCHING GEARBOX
6HP	6DG
6HFP	6DGF
8HP	8DG
8HFP	8DGF

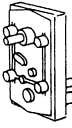
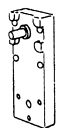

• Motors combined with gear heads are manufactured to order. The model code to be like: DME37B6DGF15B

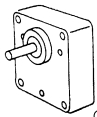
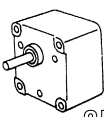
				MOTOR AND GEARBOX SUPPLIED SEPERATELY				PAGE
 50G	 5C	 L	 6DG	 6DGF	 8DG	 8DGF		
		DME25BL <input type="checkbox"/> A DME25BL <input type="checkbox"/> B	DME25B6HPA DME25B6HPB				12~14	
	DME33S5C <input type="checkbox"/> A DME33S5C <input type="checkbox"/> B	DME33SL <input type="checkbox"/> A DME33SL <input type="checkbox"/> B	DME33S6HPA DME33S6HPB				15~20	
DME33B50G <input type="checkbox"/> A DME33B50G <input type="checkbox"/> B	DME33B5C <input type="checkbox"/> A DME33B5C <input type="checkbox"/> B	DME33BL <input type="checkbox"/> A DME33BL <input type="checkbox"/> B	DME33B6HPA DME33B6HPB					
	DME34S5C <input type="checkbox"/> A DME34S5C <input type="checkbox"/> B	DME34SL <input type="checkbox"/> A DME34SL <input type="checkbox"/> B	DME34S6HPA DME34S6HPB				21~28	
DME34B50G <input type="checkbox"/> A DME34B50G <input type="checkbox"/> B	DME34B5C <input type="checkbox"/> A DME34B5C <input type="checkbox"/> B	DME34BL <input type="checkbox"/> A DME34BL <input type="checkbox"/> B	DME34B6HPA DME34B6HPB		DME34B8HPA DME34B8HPB			
	DME34K5C <input type="checkbox"/> B	DME34KL <input type="checkbox"/> B			DME34K8HPB			
DME37S50G <input type="checkbox"/> A DME37S50G <input type="checkbox"/> B			DME37S6HPA DME37S6HPB				29~33	
DME37B50G <input type="checkbox"/> A DME37B50G <input type="checkbox"/> B			DME37B6HPA DME37B6HPB	DME37B6HFPA DME37B6HFPA	DME37B8HPA DME37B8HPB			
DME37K50G <input type="checkbox"/> A DME37K50G <input type="checkbox"/> B			DME37K6HPA DME37K6HPB	DME37K6HFPA DME37K6HFPA	DME37K8HPA DME37K8HPB			
				DME37J6HFPA	DME37J8HPB	DME37J8HFPA		
DME44S50G <input type="checkbox"/> A DME44S50G <input type="checkbox"/> B			DME44S6HPA DME44S6HPB	DME44S6HFPA DME44S6HFPA	DME44S8HPA DME44S8HPB		34~37	
				DME44B6HFPA	DME44B8HPB	DME44B8HFPA		
			DME60S6HPA DME60S6HPB	DME60S6HFPA DME60S6HFPA	DME60S8HPA DME60S8HPB	DME60S8HFPA DME60S8HFPA	38~40	
				DME60B6HFPA	DME60B8HPB	DME60B8HFPA		
NOTE: <input type="checkbox"/> DENOMINATOR OF REDUCTION RATIO			6DG <input type="checkbox"/>	6DGF <input type="checkbox"/>	8DG <input type="checkbox"/>	8DGF <input type="checkbox"/>		
MODEL NAMES OF MATCHING GEARBOX.								

● GEAR-HEAD DESIGN

GEAR RATIO (Denominator)	36G	43G	50G	5C	L	6DG	6DGF	8DG	8DGF
5			○			○	○	○	○
9									
10	○	○							
12.5						○	●	○	○
15						○	●	○	○
18	●	●	○			○	●	○	○
20	●	●		●					
25						●	●	●	●
27			●						
30	●	●		●	○	●	●	●	●
36			●			●	●	●	●
40				●					
50	○	○		●	○	●	○	●	○
54			●						
60	○	○		●		●	○	●	○
72			●			●	○	●	○
75	○	○							
80				●					
96			○						
100	○	○		●		●	○	●	○
120	●	●			○	●	○	●	○
144			○						
150	●	●		●	○	○	○	●	○
180	●	●				○	○	●	○
192			○						
200	●	●		○	○				
250	●	●		○		○		○	
255					○				
256			○						
300	●	●		○		○		○	
400	○	○		○					
450						○		○	
500	○	○		○		●		●	
600	○	○						●	
750						●		●	
900						●		●	
1800						●		●	

○ : Output shaft rotates in the same direction with motor shaft.
 ● : Output shaft rotates reversed direction to motor shaft.

DME25

MODEL CODE	VOLTAGE	OUTPUT	CURRENT
BA	12V	3W	0.47A
BB	24V	3W	0.23A



● DIMENSIONS Unit mm(inch) DME25BA, DME25BB

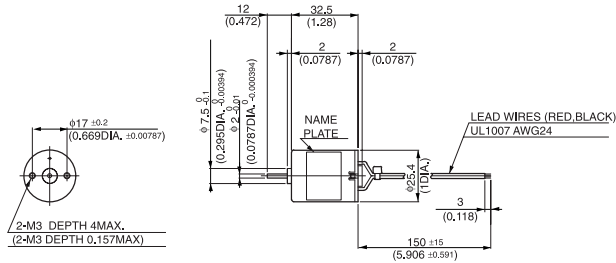

● CURRENT, SPEED-TORQUE CURVE DME25BA, DME25BB

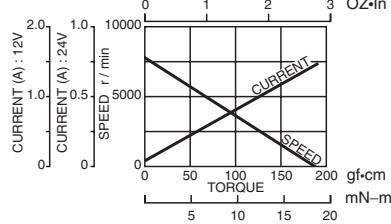

● CONNECTION

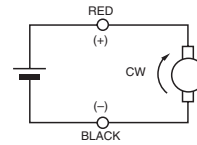

● STANDARD SPECIFICATIONS

Model	Rated					No load		Stall torque		Weight		
	Output W	Voltage V	Torque		Current A	Speed r/min	Current A	Speed r/min	mN-m	oz-in	Weight	
			mN-m	oz-in							g	lb
DME25BA	3	12	4.9	0.69	0.47	5800	0.07	8000	17.7	2.50	55	0.12
DME25BB	3	24	4.9	0.69	0.23	5800	0.04	8000	17.7	2.50	55	0.12

WITH GEARBOX 36G

Gear heads for
intermittent drive

● DIMENSIONS Unit mm(inch) DME25B36G

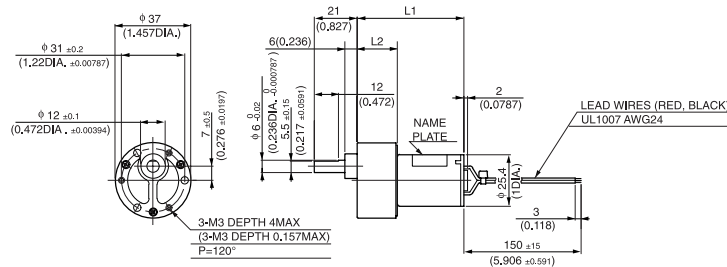

GEAR RATIO	L1		L2		WEIGHT	
	(mm)	(inch)	(mm)	(inch)	g	lb
10	52.3	2.059	19.8	0.78	160	0.35
18~30	54.8	2.157	22.3	0.878		
50~100	57.3	2.256	24.8	0.976	180	0.40
120~300	59.8	2.354	27.3	1.075		
400~600	62.3	2.453	29.8	1.173		

● with 36G TYPE GEARBOX

Model	Gear ratio		10	*18	*20	*30	50	60	75	100	*120	*150	*180
	Rated speed	r/min	580	322	290	193	116	96.6	77.3	58	48.3	40.1	35.2
DME25B36G □ ☆	Rated torque	N-m	0.04	0.068	0.071	0.1	0.15	0.18	0.23	0.32	0.34	0.39	0.39
		oz-in	5.55	9.03	10.14	15.28	22.22	26.39	33.33	45.83	48.61	55.55	55.55
Model	Gear ratio		*200	*250	*300	400	500	600					
	Rated speed	r/min	32.5	27.2	23.3	17.9	14.6	12.4					
DME25B36G □ ☆	Rated torque	N-m	0.39	0.39	0.39	0.39	0.39	0.39					
		oz-in	55.55	55.55	55.55	55.55	55.55	55.55					

NOTE 1: Enter the required reduction ratio in the □.
2: *Rotation of gearbox shaft is in reverse of rotation of motor.
3: Enter the required voltage A or B in the ☆.

WITH GEARBOX 43G

Gear heads for
intermittent drive

● DIMENSIONS Unit mm(inch) DME25B43G

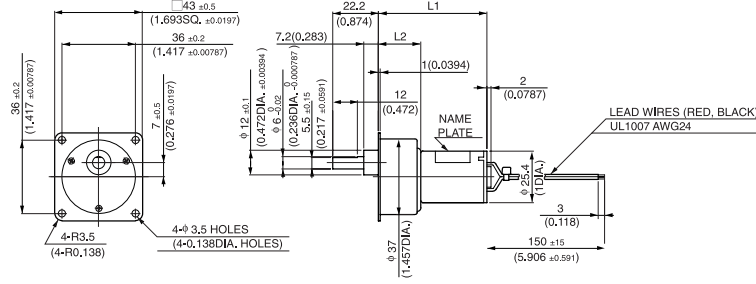

GEAR RATIO	L1		L2		WEIGHT	
	(mm)	(inch)	(mm)	(inch)	g	lb
10	50.8	2.000	18.3	0.720	160	0.35
18~30	53.3	2.098	20.8	0.819		
50~100	55.8	2.197	23.3	0.917		
120~300	58.3	2.295	25.8	1.016		
400~600	60.8	2.394	28.3	1.114		

● with 43G TYPE GEARBOX

Model	Gear ratio		10	*18	*20	*30	50	60	75	100	*120	*150
	Rated speed	r/min	580	322	290	193	116	96.6	77.3	58	48.3	40.1
DME25B43G □ ☆	Rated torque	N·m	0.04	0.068	0.071	0.1	0.15	0.18	0.23	0.32	0.34	0.39
		oz·in	5.55	9.03	10.14	15.28	22.22	26.39	33.33	45.83	48.61	55.55

Model	Gear ratio		*180	*200	*250	*300	400	500	600
	Rated speed	r/min	35.2	32.5	27.2	23.3	17.9	14.6	12.4
DME25B43G □ ☆	Rated torque	N·m	0.39	0.39	0.39	0.39	0.39	0.39	0.39
		oz·in	55.55	55.55	55.55	55.55	55.55	55.55	55.55

WITH GEARBOX L

Gear heads for
intermittent drive



● DIMENSIONS Unit mm(inch) DME25BL

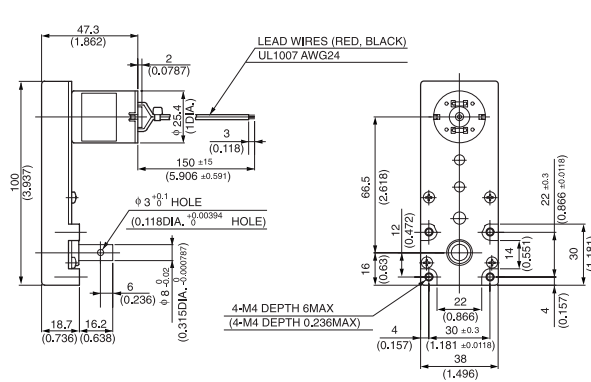

(WEIGHT 225 g 0.5 lb)

● with L TYPE GEARBOX

Model	Gear ratio		30	50	120	150	200	255
	Rated speed	r/min	193	116	48.3	38.6	29	22.7
DME25BL □ ☆	Rated torque	N·m	0.09	0.14	0.34	0.43	0.58	0.74
		oz·in	12.22	19.44	48.61	61.10	81.93	104.15

NOTE 1: Enter the required reduction ratio in the □.
2: *Rotation of gearbox shaft is in reverse of rotation of motor.
3: Enter the required voltage A or B in the ☆.

DME25

MODEL CODE	VOLTAGE	OUTPUT	CURRENT
BA	12V	3W	0.47A
BB	24V	3W	0.23A

WITH GEARBOX 6DG



6DG

● DIMENSIONS Unit mm(inch) DME25B6DG

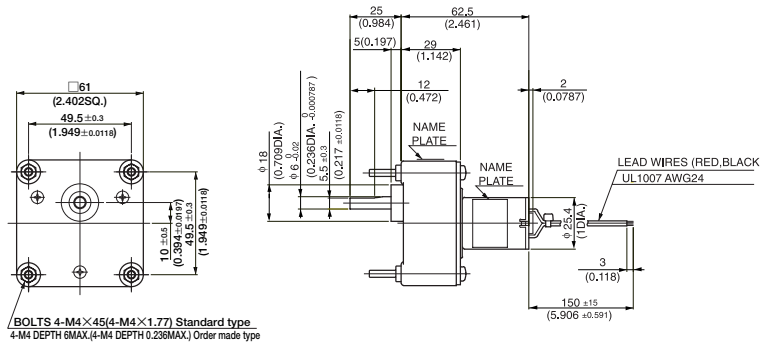

NOTE:

6DG gearbox are available with either 4.5mm diameter mounting holes or M4 x 6mm tapped holes.

- Gearboxes with 4.5mm diameter mounting holes are available from stock. When ordering, please write the motor model and gearbox model numbers separately, as in the following example:
DME25B6HPB (Pinion shaft motor)
6DG (Gearbox)

- Gearboxes with M4 x 6mm tapped mounting holes are available on request. When ordering, please write the combine motor and gearbox model, as in the following example :
DME25B6H B

(WEIGHT 355 g 0.78 lb)

● with 6DG TYPE GEARBOX MOTOR MODEL DME25B6HP ☆ & GEARBOX MODEL 6DG □

Model	Gear ratio		5	12.5	15	*25	*30	*50	*75	*100	150	180	250
		Rated speed	r/min	1160	464	386	232	193	116	77.3	58	38.6	32.2
DME25B6HP ☆ & 6DG □	Rated torque	N·m	0.02	0.05	0.06	0.1	0.11	0.18	0.27	0.36	0.49	0.59	0.82
		oz·in	2.78	6.94	8.33	12.64	15.28	25.00	37.50	49.99	68.05	81.93	113.87
Model	Gear ratio		300	450	*500	*750	*900	*1800					
	Rated speed	r/min	19.3	14.4	13	9.3	7.9	4.2					
DME25B6HP ☆ & 6DG □	Rated torque	N·m	0.96	0.98	0.98	0.98	0.98	0.98					
		oz·in	136.09	138.87	138.87	138.87	138.87	138.87					

NOTE 1: Enter the required reduction ratio in the □.
2: *Rotation of gearbox shaft is in reverse of rotation of motor.
3: Enter the required voltage A or B in the ☆.

DME33

MODEL CODE	VOLTAGE	OUTPUT	CURRENT
SA	12V	0.7W	0.12A
SB	24V	0.7W	0.06A
BA	12V	3.0W	0.42A
BB	24V	3.0W	0.22A



● DIMENSIONS Unit mm(inch)

DME33SA, DME33SB

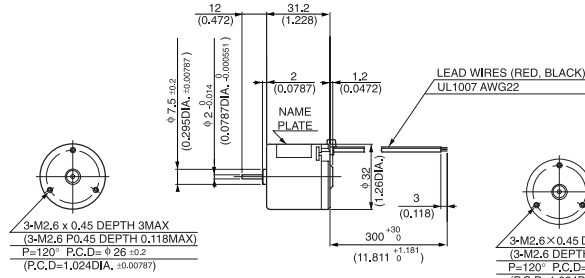

DME33BA, DME33BB

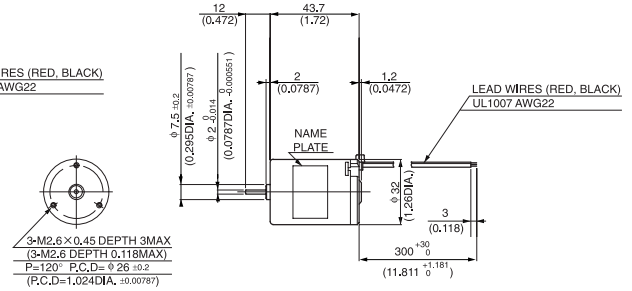

● CURRENT, SPEED-TORQUE CURVE

DME33SA, DME33SB

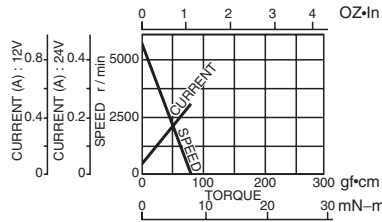

DME33BA, DME33BB

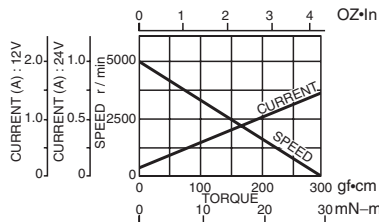

● CONNECTION

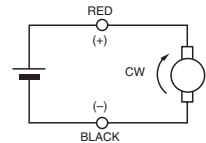

● STANDARD SPECIFICATIONS

Model	Rated					No load		Stall torque		Weight		
	Output W	Voltage V	Torque		Current A	Speed r/min	Current A	Speed r/min	mN-m	oz-in	Weight	
			mN-m	oz-in							g	lb
DME33SA	0.7	12	1.5	0.21	0.12	4500	0.05	5500	7.8	1.11	70	0.15
DME33SB	0.7	24	1.5	0.21	0.06	4500	0.02	5500	7.8	1.11	70	0.15
DME33BA	3	12	7.8	1.11	0.42	3700	0.06	5000	29	4.17	100	0.22
DME33BB	3	24	7.8	1.11	0.22	3700	0.04	5000	29	4.17	100	0.22

● REVOLUTION SENSOR MAGNET TYPE

DME33SMA, DME33SMB

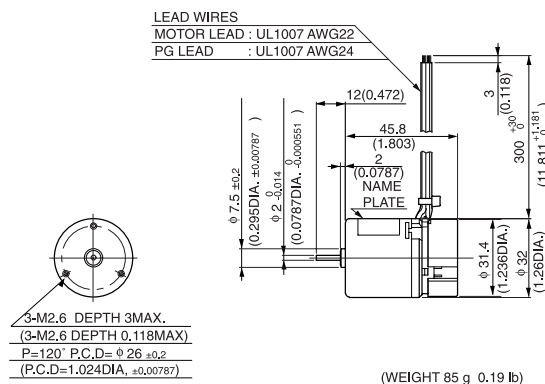

DME33BMA, DME33BMB

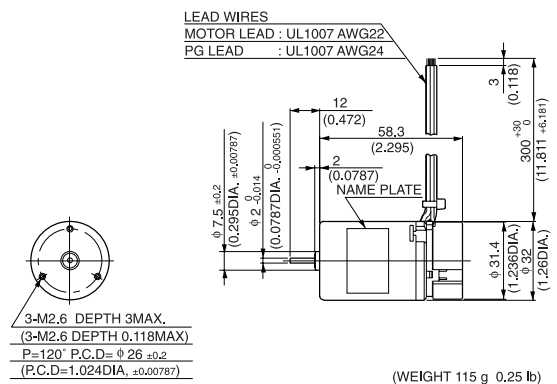

● CONNECTION OF REVOLUTION SENSOR

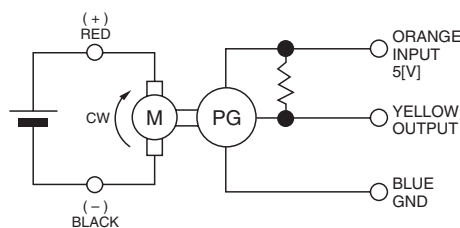

● SPECIFICATION OF REVOLUTION SENSOR SHOWN ON PAGE 8.

DME33

MODEL CODE	VOLTAGE	OUTPUT	CURRENT
SA	12V	0.7W	0.12A
SB	24V	0.7W	0.06A
BA	12V	3.0W	0.42A
BB	24V	3.0W	0.22A

WITH GEARBOX
36G

Gear heads for
intermittent drive



36G

● DIMENSIONS Unit mm(inch)
DME33S36G

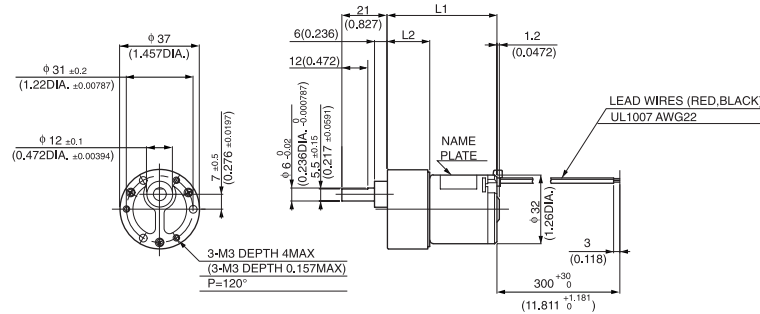

GEAR RATIO	L1		L2		WEIGHT	
	(mm)	(inch)	(mm)	(inch)	g	lb
10	51.0	2.008	19.8	0.78	170	0.37
18~30	53.5	2.106	22.3	0.878		
50~100	56.0	2.204	24.8	0.976		
120~300	58.5	2.303	27.3	1.075	190	0.42
400~600	61.0	2.402	29.8	1.173		

DME33B36G

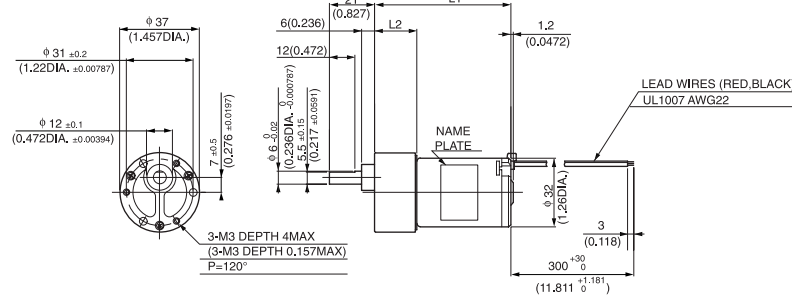

GEAR RATIO	L1		L2		WEIGHT	
	(mm)	(inch)	(mm)	(inch)	g	lb
10	63.5	2.5	19.8	0.78	200	0.44
18~30	66.0	2.598	22.3	0.878		
50~100	68.5	2.697	24.8	0.976		
120~300	71.0	2.795	27.3	1.075	220	0.49
400~600	73.5	2.894	29.8	1.173		

● with 36G TYPE GEARBOX

Model	Gear ratio		10	*18	*20	*30	50	60	75	100	*120	*150	*180
	Rated speed	r/min	450	250	225	150	90	75	60	45	37.5	30	25
DME33S36G ☆	Rated torque	N·m	0.011	0.018	0.021	0.032	0.048	0.058	0.072	0.096	0.098	0.12	0.15
		oz·in	1.67	2.64	3.06	4.58	6.80	8.19	10.28	13.61	13.89	18.05	22.22
DME33B36G ☆	Rated speed	r/min	370	205	185	123	74	61.6	49.3	40	34	28.4	24.4
		Rated torque	N·m	0.063	0.1	0.11	0.16	0.25	0.3	0.38	0.39	0.39	0.39
		oz·in	9.03	13.89	15.28	23.61	36.11	43.05	54.16	55.55	55.55	55.55	55.55
Model	Gear ratio		*200	*250	*300	400	500	600					
	Rated speed	r/min	22.5	18	15	11.2	9	7.7					
DME33S36G ☆	Rated torque	N·m	0.16	0.21	0.25	0.31	0.39	0.39					
		oz·in	23.61	30.55	36.11	44.44	55.55	55.55					
DME33B36G ☆	Rated speed	r/min	22.2	18.2	15.4	11.7	9.5	8					
		Rated torque	N·m	0.39	0.39	0.39	0.39	0.39	0.39				
		oz·in	55.55	55.55	55.55	55.55	55.55	55.55					

NOTE 1: Enter the required reduction ratio in the □.
2: *Rotation of gearbox shaft is in reverse of rotation of motor.
3: Enter the required voltage A or B in the ☆.

WITH GEARBOX 43G

Gear heads for
intermittent drive



43G

● DIMENSIONS Unit mm(inch) DME33S43G

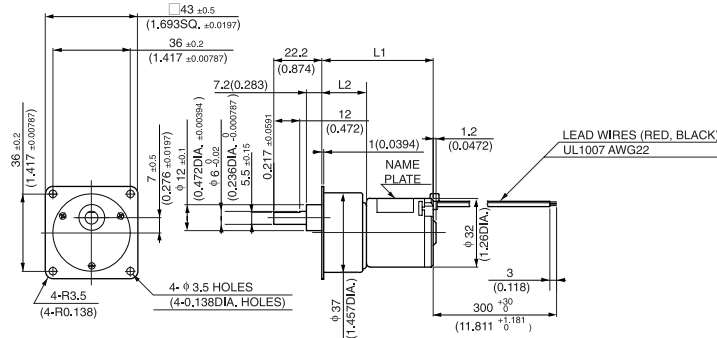

GEAR RATIO	L1		L2		WEIGHT	
	(mm)	(inch)	(mm)	(inch)	g	lb
10	49.5	1.949	18.3	0.720	200	0.44
18-30	52	2.047	20.8	0.819		
50-100	54.5	2.146	23.3	0.917		
120-300	57	2.244	25.8	1.016		
400-600	59.5	2.343	28.3	1.114		

DME33B43G

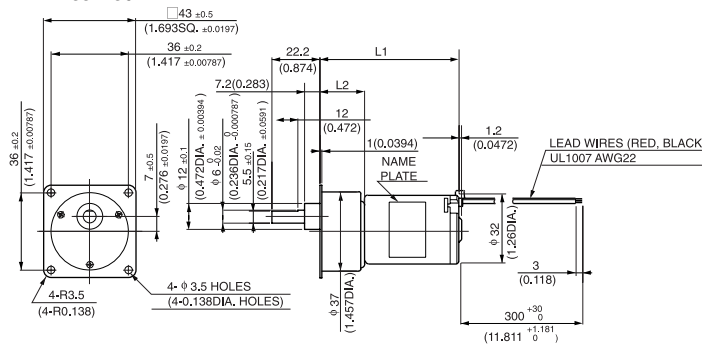

GEAR RATIO	L1		L2		WEIGHT	
	(mm)	(inch)	(mm)	(inch)	g	lb
10	62	2.441	18.3	0.720	220	0.49
18-30	64.5	2.539	20.8	0.819		
50-100	67	2.638	23.3	0.917		
120-300	69.5	2.736	25.8	1.016		
400-600	72	2.835	28.3	1.114		

● with 43G TYPE GEARBOX

Model	Gear ratio		10	*18	*20	*30	50	60	75	100	*120	*150
		Rated speed	r/min	450	250	225	150	90	75	60	45	37.5
DME33S43G □ ☆	Rated torque	N·m	0.011	0.018	0.021	0.032	0.048	0.058	0.072	0.096	0.098	0.12
		oz·in	1.67	2.64	3.06	4.58	6.80	8.19	10.28	13.61	13.89	18.05
DME33B43G □ ☆	Rated speed	r/min	370	205	185	123	74	61.6	49.3	40	34	28.4
	Rated torque	N·m	0.064	0.1	0.11	0.16	0.25	0.3	0.38	0.39	0.39	0.39
		oz·in	9.03	13.89	15.28	23.61	36.11	43.05	54.16	55.55	55.55	55.55

Model	Gear ratio		*180	*200	*250	*300	400	500	600
		Rated speed	r/min	25	22.5	18	15	11.2	9
DME33S43G □ ☆	Rated torque	N·m	0.15	0.16	0.21	0.25	0.31	0.39	0.39
		oz·in	22.22	23.61	30.55	36.11	44.44	55.55	55.55
DME33B43G □ ☆	Rated speed	r/min	24.4	22.2	18.2	15.4	11.7	9.5	8
	Rated torque	N·m	0.39	0.39	0.39	0.39	0.39	0.39	0.39
		oz·in	55.55	55.55	55.55	55.55	55.55	55.55	55.55

NOTE 1: Enter the required reduction ratio in the □.
2: *Rotation of gearbox shaft is in reverse of rotation of motor.
3: Enter the required voltage A or B in the ☆.

DME33

MODEL CODE	VOLTAGE	OUTPUT	CURRENT
SA	12V	0.7W	0.12A
SB	24V	0.7W	0.06A
BA	12V	3.0W	0.42A
BB	24V	3.0W	0.22A

WITH GEARBOX 50G



50G

● DIMENSIONS Unit mm(inch) DME33B50G

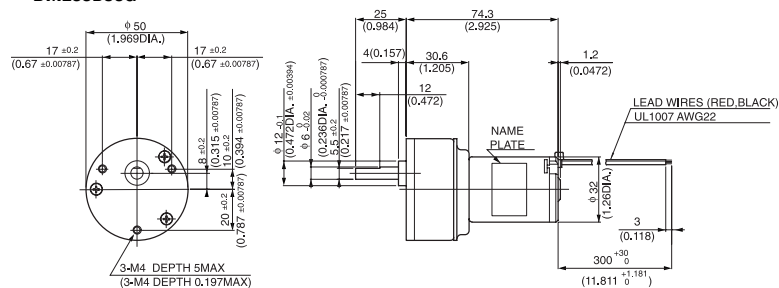

(WEIGHT 300g 0.66 lb)

● with 50G TYPE GEARBOX

Model	Gear ratio		9	18	*27	*36	*54	*72	96	144	192	256
	Rated speed	r/min	411	205	137	102	68.5	51.3	38.5	25.7	19.3	15.7
DME33B50G <input type="checkbox"/> ☆	Rated torque	N-m	0.057	0.11	0.15	0.21	0.3	0.41	0.49	0.74	0.98	0.98
		oz-in	8.05	15.28	20.83	29.16	43.05	58.33	69.44	104.15	138.87	138.87

WITH GEARBOX L

Gear heads for
intermittent drive



L

● DIMENSIONS Unit mm(inch) DME33SL

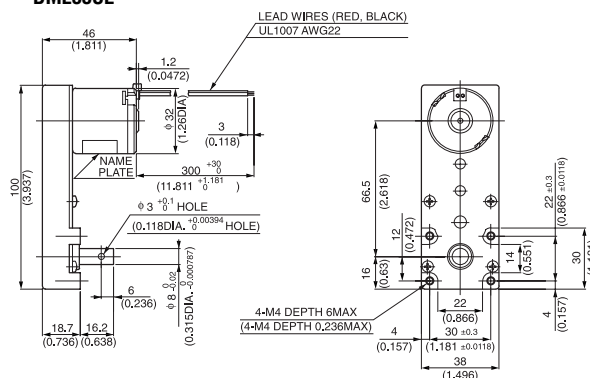

(WEIGHT 240 g 0.53 lb)

DME33BL

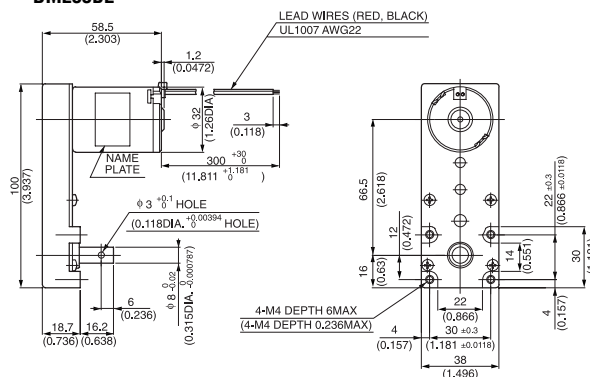

(WEIGHT 270 g 0.6 lb)

● with L TYPE GEARBOX

Model	Gear ratio		30	50	120	150	200	255
	Rated speed	r/min	150	90	37.5	30	22.5	17.6
DME33SL <input type="checkbox"/> ☆	Rated torque	N-m	0.025	0.043	0.098	0.13	0.17	0.22
		oz-in	3.61	6.11	13.89	18.05	23.61	30.55
DME33BL <input type="checkbox"/> ☆	Rated speed	r/min	139	83.7	34.9	27.9	20.9	16.4
		N-m	0.086	0.14	0.34	0.43	0.58	0.74
		oz-in	12.22	19.44	48.61	61.10	81.93	104.15

NOTE 1: Enter the required reduction ratio in the .
2: *Rotation of gearbox shaft is in reverse of rotation of motor.
3: Enter the required voltage A or B in the ☆.

WITH GEARBOX

5C

Gear heads for intermittent drive



5C

● DIMENSIONS Unit mm(inch)
DME33S5C

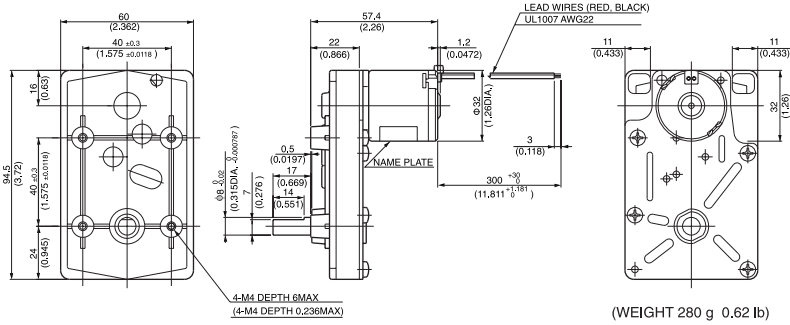

(WEIGHT 280 g 0.62 lb)

DME33B5C

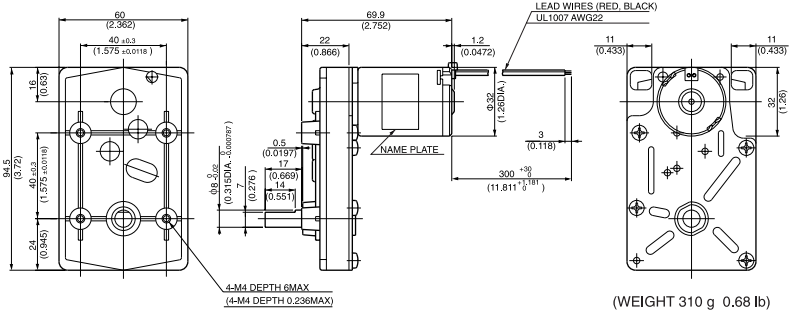

(WEIGHT 310 g 0.68 lb)

● with 5C TYPE GEARBOX

Model	Gear ratio		*20	*30	*40	*50	*60	*80	*100	*150	200	250
		Rated speed	r/min	225	150	112	90	75	56.2	45	30	22.5
DME33S5C □ ☆	Rated torque	N·m	0.022	0.032	0.043	0.053	0.064	0.085	0.11	0.16	0.19	0.24
		oz·in	3.06	4.58	6.11	7.50	9.03	12.08	15.28	22.22	26.39	33.33
DME33B5C □ ☆	Rated speed	r/min	185	123	92.5	74	61.6	46.2	37	24.6	18.8	16
		N·m	0.11	0.17	0.23	0.28	0.34	0.46	0.57	0.85	0.98	0.98
	Rated torque	oz·in	15.28	23.61	31.94	40.27	48.61	63.88	80.55	120.82	138.87	138.87
Model	Gear ratio		300	400	500							
	Rated speed	r/min	15	11.2	9							
DME33S5C □ ☆	Rated torque	N·m	0.28	0.38	0.48							
		oz·in	40.27	54.16	68.05							
DME33B5C □ ☆	Rated speed	r/min	13.9	10.9	9							
		N·m	0.98	0.98	0.98							
	Rated torque	oz·in	138.87	138.87	138.87							

NOTE 1: Enter the required reduction ratio in the □.
2: *Rotation of gearbox shaft is in reverse of rotation of motor.
3: Enter the required voltage A or B in the ☆.

DME33

WITH GEARBOX 6DG



6DG

● DIMENSIONS Unit mm(inch) DME33S6DG

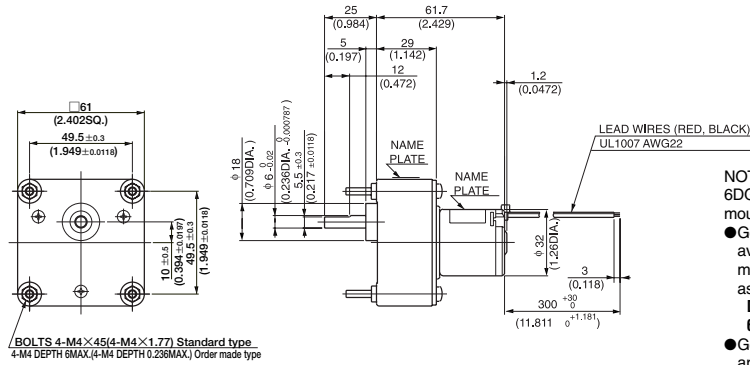

(WEIGHT 370 g 0.82 lb)

DME33B6DG

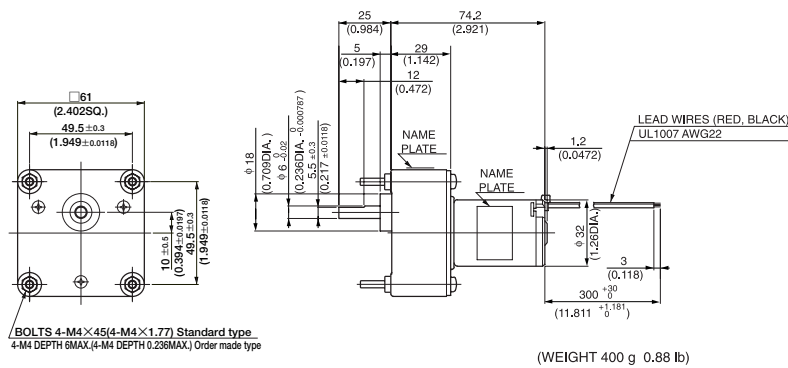

● with 6DG TYPE GEARBOX MOTOR MODEL DME33S6HP☆ or DME33B6HP☆ & GEARBOX MODEL 6DG□

Model	Gear ratio												
	Rated speed	r/min	900	360	300	180	150	90	60	45	30	25	18
DME33S6HP☆ & 6DG□	Rated torque	N-m	0.006	0.015	0.018	0.026	0.032	0.053	0.08	0.11	0.14	0.17	0.24
		oz-in	0.83	2.08	2.50	3.75	4.58	7.50	11.39	15.28	19.44	23.61	33.33
DME33B6HP☆ & 6DG□	Rated speed	r/min	740	296	246	148	123	74	49.3	37	24.6	20.5	16
		Rated torque	N-m	0.031	0.079	0.095	0.14	0.17	0.28	0.42	0.57	0.77	0.92
	oz-in		4.44	11.25	13.47	19.44	23.61	40.27	59.71	80.55	108.32	130.54	138.87
Model	Gear ratio												
	Rated speed	r/min	15	10	9	6	5	2.4					
DME33S6HP☆ & 6DG□	Rated torque	N-m	0.28	0.43	0.43	0.65	0.77	0.98					
		oz-in	40.27	61.10	61.10	91.66	109.71	138.87					
DME33B6HP☆ & 6DG□	Rated speed	r/min	13.9	9.9	8.9	6.1	5.2	2.7					
		Rated torque	N-m	0.98	0.98	0.98	0.98	0.98	0.98				
	oz-in		138.87	138.87	138.87	138.87	138.87	138.87					

NOTE 1: Enter the required reduction ratio in the □.
2: *Rotation of gearbox shaft is in reverse of rotation of motor.
3: Enter the required voltage A or B in the ☆.

DME34

MODEL CODE	VOLTAGE	OUTPUT	CURRENT
SA	12V	1.3W	0.2A
SB	24V	1.3W	0.1A
BA	12V	4.5W	0.65A
BB	24V	4.5W	0.31A
KB	24V	7W	0.41A



● DIMENSIONS Unit mm(inch)

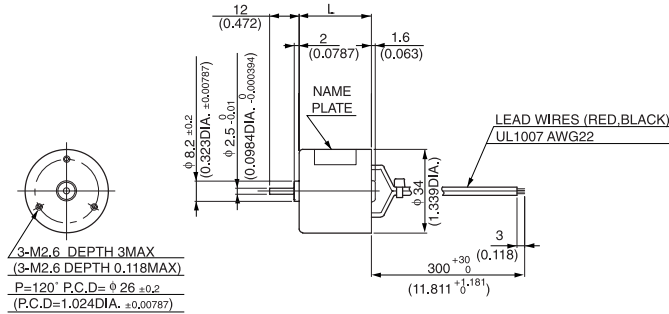

Model	L	Weight	
		g	lb
DME34SA	29.5	100	0.22
DME34SB	29.5	100	0.22
DME34BA	35.0	110	0.24
DME34BB	35.0	110	0.24
DME34KB	45	140	0.31

● CONNECTION

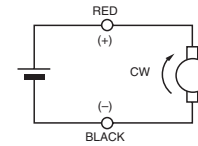

● CURRENT, SPEED-TORQUE CURVE

DME34SA, DME34SB

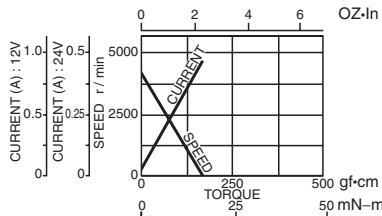

DME34BA, DME34BB

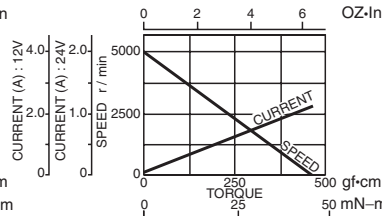

DME34KB

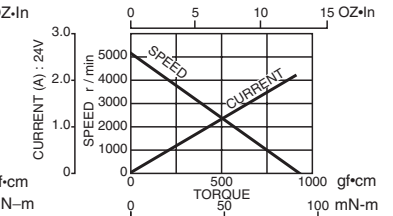

● STANDARD SPECIFICATIONS

Model	Rated					No load		Stall torque		
	Output W	Voltage V	Torque		Current A	Speed r/min	Current A	Speed r/min	mN·m	oz·in
			mN·m	oz·in						
DME34SA	1.3	12	3.9	0.56	0.2	3300	0.04	4300	17	2.36
DME34SB	1.3	24	3.9	0.56	0.1	3300	0.02	4300	17	2.36
DME34BA	4.5	12	11.8	1.67	0.65	3700	0.07	5000	45	6.39
DME34BB	4.5	24	11.8	1.67	0.31	3700	0.04	5000	45	6.39
DME34KB	7	24	14.7	2.08	0.41	4300	0.06	5100	92	13.03

● REVOLUTION SENSOR MAGNET TYPE

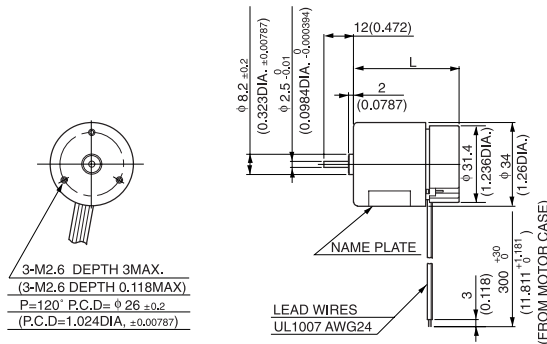

Model	L	Weight	
		g	lb
DME34SMA	43.1	110	0.24
DME34SMB	43.1	110	0.24
DME34BMA	48.6	120	0.26
DME34BMB	48.6	120	0.26
DME34KMB	58.6	150	0.33

DME34

MODEL CODE	VOLTAGE	OUTPUT	CURRENT
SA	12V	1.3W	0.2A
SB	24V	1.3W	0.1A
BA	12V	4.5W	0.65A
BB	24V	4.5W	0.31A
KB	24V	7W	0.41A

● REVOLUTION SENSOR OPTICAL TYPE

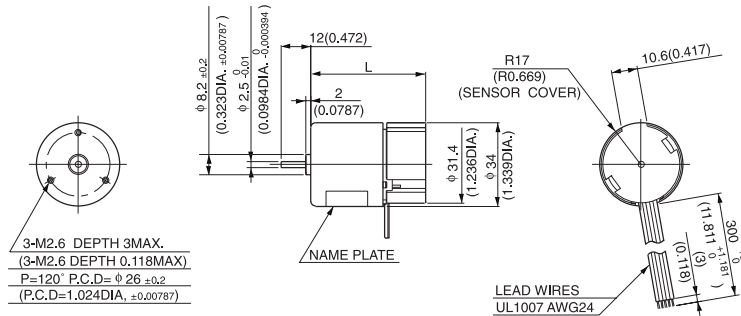

Model	L	Weight	
		g	lb
DME34SEA	47.1	120	0.26
DME34SEB			
DME34BEA	52.6	130	0.29
DME34BEB			
DME34KEB	62.6	160	0.35

● CONNECTION OF REVOLUTION SENSOR

DME34SMA, DME34SMB, DME34BMA, DME34BMB
DME34SEA, DME34SEB, DME34BEA, DME34BEB

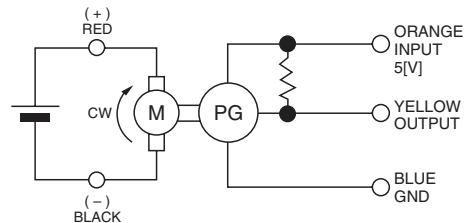

● SPECIFICATION OF REVOLUTION SENSOR ARE SHOWN ON PAGE 8.

WITH GEARBOX

36G

Gear heads for
intermittent drive



36G

● DIMENSIONS Unit mm(inch)

DME34S36G

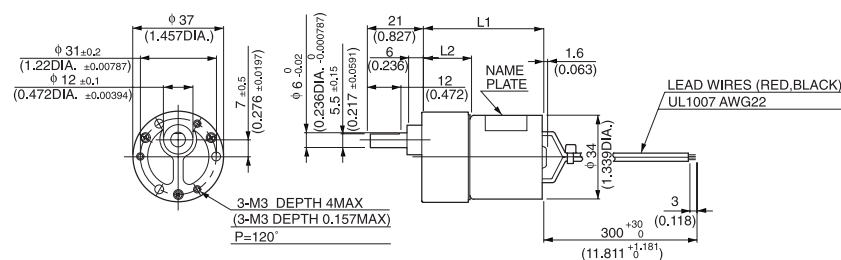

GEAR RATIO	L1		L2		WEIGHT	
	(mm)	(inch)	(mm)	(inch)	g	lb
10	49.3	1.941	19.8	0.78	200	0.44
18~30	51.8	2.039	22.3	0.878		
50~100	54.3	2.138	24.8	0.976	220	0.49
120~300	56.8	2.236	27.3	1.075		
400~600	59.3	2.335	29.8	1.173		

WITH GEARBOX
36G

Gear heads for
intermittent drive

DME34B36G

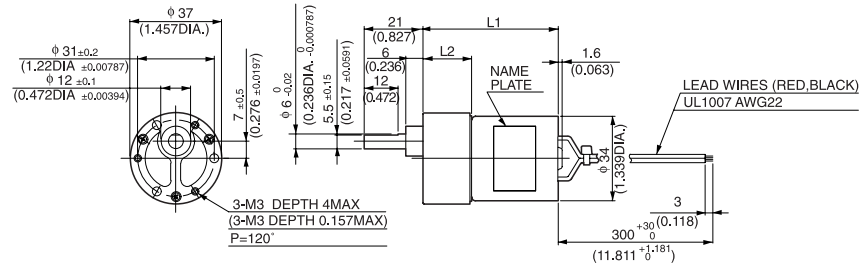

GEAR RATIO	L1		L2		WEIGHT	
	(mm)	(inch)	(mm)	(inch)	g	lb
10	54.8	2.157	19.8	0.78	210	0.46
18-30	57.3	2.256	22.3	0.878		
50-100	59.8	2.354	24.8	0.976		
120-300	62.6	2.465	27.3	1.075	230	0.51
400-600	64.8	2.551	29.8	1.173		

●with 36G TYPE GEARBOX

Model	Gear ratio		10	*18	*20	*30	50	60	75	100	*120	*150	*180
	Rated speed	r/min	330	183	165	110	66	55	44	33	27.5	22	18.6
DME34S36G □ ☆	Rated torque	N·m	0.031	0.052	0.06	0.09	0.12	0.14	0.18	0.25	0.27	0.34	0.39
		oz·in	4.44	7.22	8.33	12.50	18.05	20.83	26.39	36.11	38.88	48.61	55.55
DME34B36G □ ☆	Rated speed	r/min	370	205	185	123	74	65	54.9	43.4	36.5	30	25.5
		Rated torque	N·m	0.095	0.14	0.16	0.25	0.38	0.39	0.39	0.39	0.39	0.39
		oz·in	13.47	20.83	23.61	36.11	54.16	55.55	55.55	55.55	55.55	55.55	55.55
Model	Gear ratio		*200	*250	*300	400	500	600					
	Rated speed	r/min	17.2	14.5	12.4	9.5	7.8	6.6					
DME34S36G □ ☆	Rated torque	N·m	0.39	0.39	0.39	0.39	0.39	0.39					
		oz·in	55.55	55.55	55.55	55.55	55.55	55.55					
DME34B36G □ ☆	Rated speed	r/min	23.1	18.8	15.8	12	9.6	8.1					
		Rated torque	N·m	0.39	0.39	0.39	0.39	0.39	0.39				
		oz·in	55.55	55.55	55.55	55.55	55.55	55.55					

NOTE 1: Enter the required reduction ratio in the □.
 2: *Rotation of gearbox shaft is in reverse of rotation of motor.
 3: Enter the required voltage A or B in the ☆.

DME34

WITH GEARBOX

43G

Gear heads for
intermittent drive



43G

● DIMENSIONS Unit mm(inch)
DME34S43G

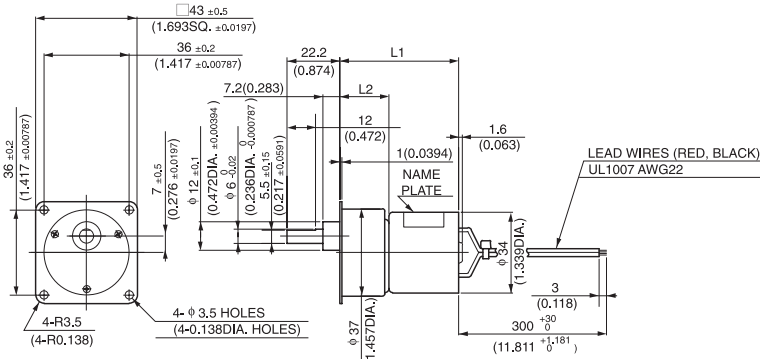

GEAR RATIO	L1		L2		WEIGHT	
	(mm)	(inch)	(mm)	(inch)	g	lb
10	47.8	1.882	18.3	0.720	200	0.44
18~30	50.3	1.980	20.8	0.819		
50~100	52.8	2.079	23.3	0.917		
120~300	55.3	2.177	25.8	1.016		
400~600	57.8	2.276	28.3	1.114		

DME34B43G

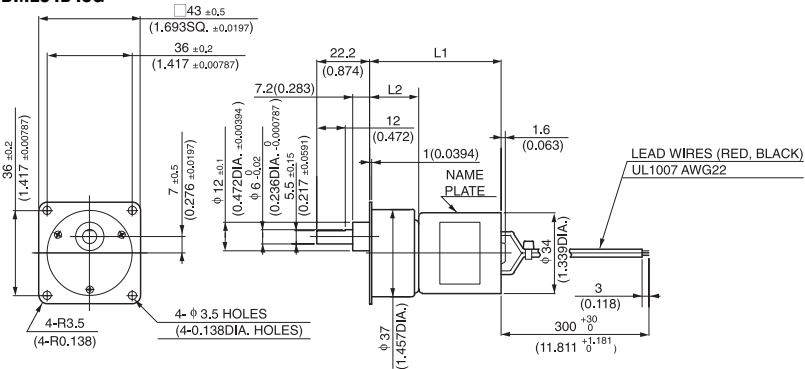

GEAR RATIO	L1		L2		WEIGHT	
	(mm)	(inch)	(mm)	(inch)	g	lb
10	53.3	2.098	18.3	0.720	210	0.46
18~30	55.8	2.197	20.8	0.819		
50~100	58.3	2.295	23.3	0.917		
120~300	60.8	2.394	25.8	1.016		
400~600	63.3	2.492	28.3	1.114		

●with 43G TYPE GEARBOX

Model	Gear ratio		10	*18	*20	*30	50	60	75	100	*120	*150
	Rated speed	r/min	330	183	165	110	66	55	44	33	27.5	22
DME34S43G □ ☆	Rated torque	N·m	0.031	0.052	0.06	0.09	0.12	0.14	0.18	0.25	0.27	0.34
		oz·in	4.44	7.22	8.33	12.50	18.05	20.83	26.39	36.11	38.88	48.61
DME34B43G □ ☆	Rated speed	r/min	370	205	185	123	74	65	54.9	43.4	36.5	30
		Rated torque	N·m	0.095	0.14	0.16	0.25	0.38	0.39	0.39	0.39	0.39
			oz·in	13.47	20.83	23.61	36.11	54.16	55.55	55.55	55.55	55.55

Model	Gear ratio		*180	*200	*250	*300	400	500	600
	Rated speed	r/min	18.6	17.2	14.5	12.4	9.5	7.8	6.6
DME34S43G □ ☆	Rated torque	N·m	0.39	0.39	0.39	0.39	0.39	0.39	0.39
		oz·in	55.55	55.55	55.55	55.55	55.55	55.55	55.55
DME34B43G □ ☆	Rated speed	r/min	25.5	23.1	18.8	15.8	12	9.6	8.1
		Rated torque	N·m	0.39	0.39	0.39	0.39	0.39	0.39
			oz·in	55.55	55.55	55.55	55.55	55.55	55.55

WITH GEARBOX
50G



50G

●DIMENSIONS Unit mm(inch)
DME34B50G

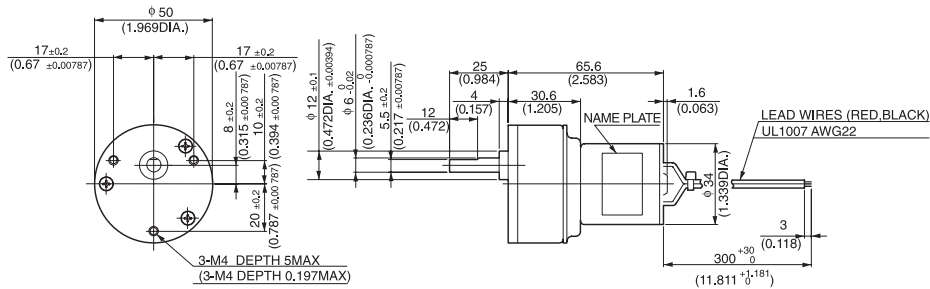

(WEIGHT 310g 0.68lb)

●with 50G TYPE GEARBOX

Model	Gear ratio		9	18	*27	*36	*54	*72	96	144	192	256
	Rated speed	r/min	411	205	137	102	68.5	51.4	38.5	26.7	21.5	17
DME34B50G □ ☆	Rated torque	N·m	0.085	0.17	0.23	0.3	0.46	0.62	0.74	0.98	0.98	0.98
		oz·in	12.08	23.61	31.94	43.05	65.27	87.49	104.15	138.87	138.87	138.87

WITH GEARBOX
L

Gear heads for
intermittent drive



L

●DIMENSIONS Unit mm(inch)

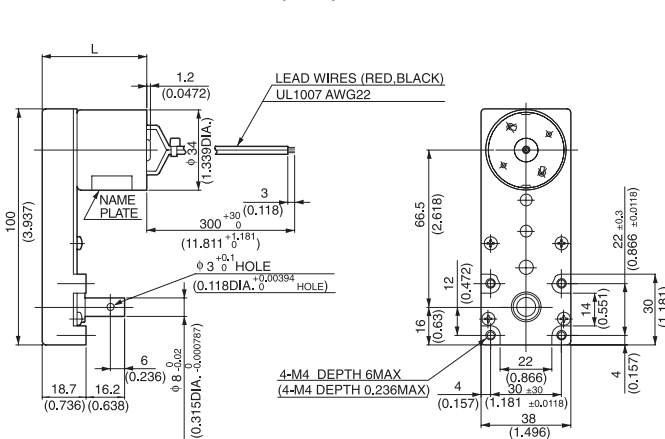

Model	L	Weight	
		g	lb
DME34SL	44.3	270	0.6
DME34BL	49.8	280	0.62
DME34KL	59.8	310	0.68

NOTE 1: Enter the required reduction ratio in the □.
2: *Rotation of gearbox shaft is in reverse of rotation of motor.
3: Enter the required voltage A or B in the ☆.

DME34

MODEL CODE	VOLTAGE	OUTPUT	CURRENT
SA	12V	1.3W	0.2A
SB	24V	1.3W	0.1A
BA	12V	4.5W	0.65A
BB	24V	4.5W	0.31A
KB	24V	7W	0.41A

WITH GEARBOX

L

Gear heads for intermittent drive

●with L TYPE GEARBOX

Model	Gear ratio		30	50	120	150	200	255
	Rated speed	r/min	110	66	27	22	16	13
DME34SL□☆	Rated torque	N·m	0.07	0.11	0.28	0.34	0.46	0.59
		oz·in	9.72	15.28	38.88	48.61	65.27	83.32
DME34BL□☆	Rated speed	r/min	123	74	30.8	25.1	20.4	16.8
		Rated torque	N·m	0.21	0.34	0.83	0.98	0.98
oz·in	29.16		48.61	118.04	138.87	138.87	138.87	
DME34KL□B	Rated speed	r/min	143	86.0	36.2	30.0	23.2	18.6
		Rated torque	N·m	0.26	0.43	0.98	0.98	0.98
oz·in	36.81		60.88	138.87	138.87	138.87	138.87	

NOTE 1: Enter the required reduction ratio in the □.
 2: *Rotation of gearbox shaft is in reverse of rotation of motor.
 3: Enter the required voltage A or B in the ☆.

WITH GEARBOX

5C

Gear heads for intermittent drive



5C

●DIMENSIONS Unit mm(inch)

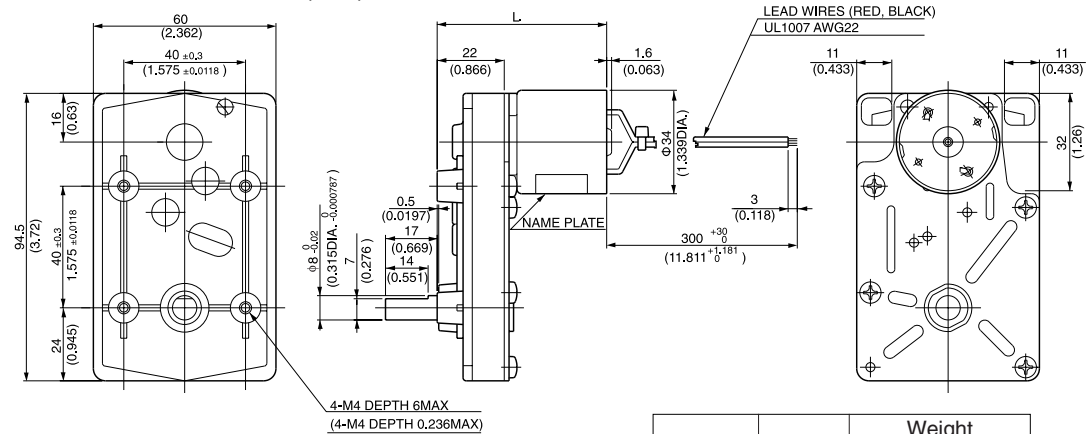

Model	L	Weight	
		g	lb
DME34S5C	55.7	310	0.68
DME34B5C	61.2	320	0.71
DME34K5C	71.2	350	0.77

●with 5C TYPE GEARBOX

Model	Gear ratio		*20	*30	*40	*50	*60	*80	*100	*150	200	250
	Rated speed	r/min	165	110	82.5	66	55	41.2	33	22	16.5	13.2
DME34S5C□☆	Rated torque	N·m	0.057	0.085	0.11	0.14	0.17	0.23	0.28	0.42	0.51	0.64
		oz·in	8.05	12.08	15.28	19.44	23.61	31.94	40.27	59.71	72.21	90.27
DME34B5C□☆	Rated speed	r/min	185	123	92.5	74	61.6	46.2	37	26.7	20.8	17.3
		Rated torque	N·m	0.17	0.25	0.34	0.42	0.51	0.69	0.85	0.98	0.98
oz·in	23.61		36.11	48.61	59.71	72.21	97.21	120.82	138.87	138.87	138.87	
DME34K5C□B	Rated speed	r/min	215	143	107	86.0	71.6	53.7	43.7	30.7	23.4	19.1
		Rated torque	N·m	0.21	0.32	0.43	0.53	0.64	0.85	0.98	0.98	0.98
oz·in	29.73		45.31	60.88	75.04	90.62	120.35	138.87	138.87	138.87	138.87	

Model	Gear ratio		300	400	500
	Rated speed	r/min	11	8.3	7
DME34S5C□☆	Rated torque	N·m	0.77	0.98	0.98
		oz·in	108.32	138.87	138.87
DME34B5C□☆	Rated speed	r/min	14.8	11.4	9.3
		Rated torque	N·m	0.98	0.98
oz·in	138.87		138.87	138.87	
DME34K5C□B	Rated speed	r/min	16.1	12.2	9.87
		Rated torque	N·m	0.98	0.98
oz·in	138.87		138.87	138.87	

NOTE 1: Enter the required reduction ratio in the □.
 2: *Rotation of gearbox shaft is in reverse of rotation of motor.
 3: Enter the required voltage A or B in the ☆.

WITH GEARBOX 6DG



6DG

● DIMENSIONS Unit mm(inch)

DME34S6DG

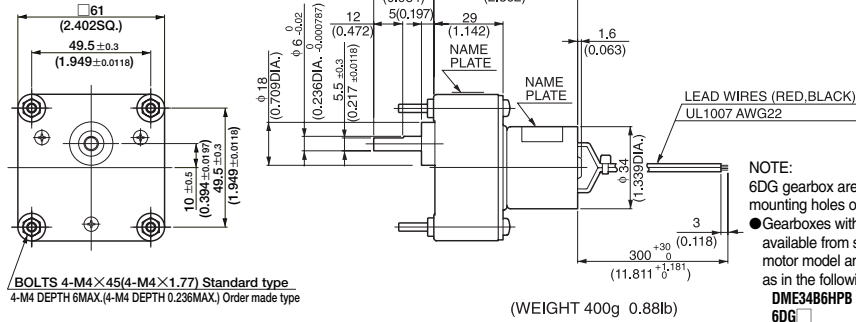

BOLTS 4-M4×45(4-M4×1.77) Standard type
4-M4 DEPTH 6MAX.(4-M4 DEPTH 0.236MAX.) Order made type

(WEIGHT 400g 0.88lb)

NOTE:
6DG gearbox are available with either 4.5mm diameter mounting holes or M4 x 6mm tapped holes.

● Gearboxes with 4.5mm diameter mounting holes are available from stock. When ordering, please write the motor model and gearbox model numbers separately, as in the following example:

DME34B6HPB (Pinion shaft motor)
6DG (Gearbox)

● Gearboxes with M4 x 6mm tapped mounting holes are available on request. When ordering, please write the combine motor and gearbox model, as in the following example : DME34B6H B

DME34B6DG

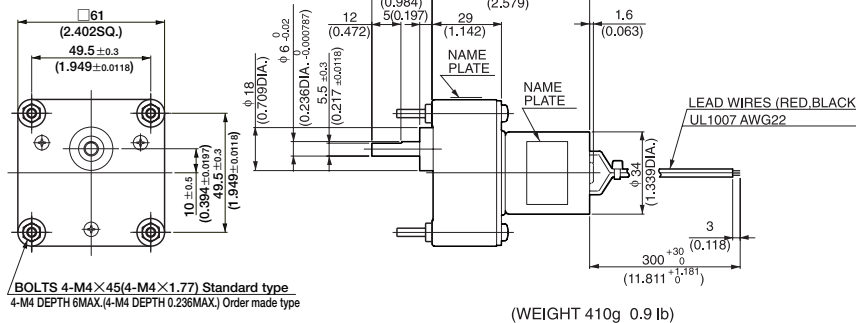

BOLTS 4-M4×45(4-M4×1.77) Standard type
4-M4 DEPTH 6MAX.(4-M4 DEPTH 0.236MAX.) Order made type

(WEIGHT 410g 0.9 lb)

● with 6DG TYPE GEARBOX MOTOR MODEL DME34S6HP☆, DME34B6HP☆ & GEARBOX MODEL 6DG□

Model	Gear ratio		5	12.5	15	*25	*30	*50	*75	*100	150	180	250
	Rated speed	r/min	660	264	220	132	110	66	44	33	22	18.3	13.2
DME34S6HP☆ & 6DG□	Rated torque	N-m	0.016	0.04	0.048	0.072	0.085	0.14	0.22	0.28	0.38	0.46	0.64
		oz-in	2.22	5.55	6.67	10.14	12.08	19.44	30.55	40.27	54.16	65.27	90.27
DME34B6HP☆ & 6DG□	Rated speed	r/min	740	296	246	148	123	74	49.3	37	26	22.7	17.3
		N-m	0.047	0.12	0.14	0.22	0.26	0.42	0.64	0.85	0.98	0.98	0.98
DME34B6HP☆ & 6DG□	Rated torque	oz-in	6.67	16.66	19.44	30.55	36.11	59.71	90.27	120.82	138.87	138.87	138.87

Model	Gear ratio		300	450	*500	*750	*900	*1800
	Rated speed	r/min	11	7.6	6.9	5	4.2	2.2
DME34S6HP☆ & 6DG□	Rated torque	N-m	0.76	0.98	0.98	0.98	0.98	0.98
		oz-in	108.32	138.87	138.87	138.87	138.87	138.87
DME34B6HP☆ & 6DG□	Rated speed	r/min	14.8	10.3	9.2	6.3	5.3	2.7
		N-m	0.98	0.98	0.98	0.98	0.98	0.98
DME34B6HP☆ & 6DG□	Rated torque	oz-in	138.87	138.87	138.87	138.87	138.87	138.87

DME34

WITH GEARBOX
8DG



8DG

MODEL CODE	VOLTAGE	OUTPUT	CURRENT
SA	12V	1.3W	0.2A
SB	24V	1.3W	0.1A
BA	12V	4.5W	0.65A
BB	24V	4.5W	0.31A
KB	24V	7W	0.41A

●DIMENSIONS Unit mm(inch)
DME34B8DG

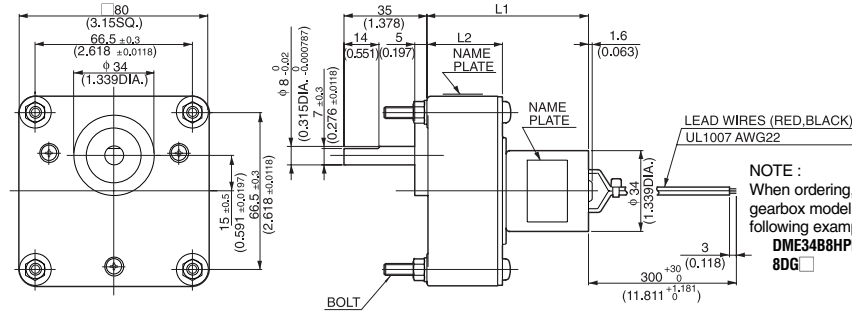

NOTE :
When ordering, please write the motor model and gearbox model numbers separately, as in the following example:
DME34B8HPB (Pinion shaft motor)
8DG (Gearbox)

GEAR RATIO	L1		L2		BOLT		WEIGHT	
	(mm)	(inch)	(mm)	(inch)	(mm)	(inch)	kg	lb
30~150	68.5	2.697	32	1.26	M5X50	M5X1.969	0.61	1.34
250~1800	78.5	3.090	42	1.65	M5X60	M5X2.362	0.71	1.56

●DIMENSIONS Unit mm(inch)
DME34K8H

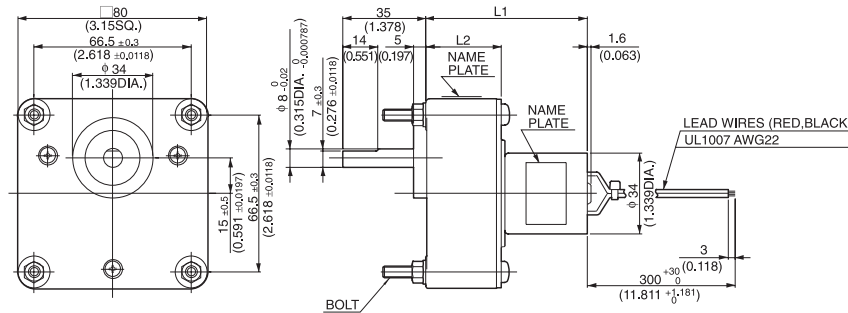

GEAR RATIO	L1		L2		BOLT		WEIGHT	
	(mm)	(inch)	(mm)	(inch)	(mm)	(inch)	kg	lb
30~150	78.5	3.090	32	1.26	M5X50	M5X1.969	0.75	1.65
250~1800	88.5	3.484	42	1.65	M5X60	M5X2.362	0.85	1.87

●with 8DG TYPE GEARBOX MOTOR MODEL **DME34B8HP**☆ & GEARBOX MODEL **8DG**□

Model	Gear ratio	*30	*50	*75	*100	*150	250	300	*500	*750	*1800	
												Rated speed
DME34B8HP ☆ & 8DG □	Rated torque	N-m	0.25	0.42	0.64	0.85	1.3	1.9	2.3	3.4	3.9	3.9
		oz-in	36.11	59.71	90.27	120.82	180.53	263.86	319.40	486.05	555.49	555.49
DME34K8HP ☆ & 8DG □	Rated speed	r/min	143	86.0	57.3	43.0	28.6	17.2	14.3	8.7	6.1	2.7
		Rated torque	N-m	0.32	0.53	0.80	1.0	1.6	2.4	2.9	3.9	3.9
	oz-in		45.31	75.04	113.27	141.59	226.54	339.82	410.61	555.49	555.49	555.49

NOTE 1: Enter the required reduction ratio in the □.
2: *Rotation of gearbox shaft is in reverse of rotation of motor.
3: Enter the required voltage A or B in the ☆.

DME37

MODEL CODE	VOLTAGE	OUTPUT	CURRENT
SA	12V	4.6W	0.78A
SB	24V	4.6W	0.37A
BA	12V	7.2W	1.01A
BB	24V	7.2W	0.53A
KA	12V	9.2W	1.20A
KB	24V	9.2W	0.60A
JB	24V	17.2W	1.07A

● DIMENSIONS Unit mm(inch)



3-M3 DEPTH 4MAX.
(3-M3 DEPTH 0.157MAX)
P=120° P.C.D=φ 28 ±0.2
(P.C.D=1.102DIA. ±0.00787)

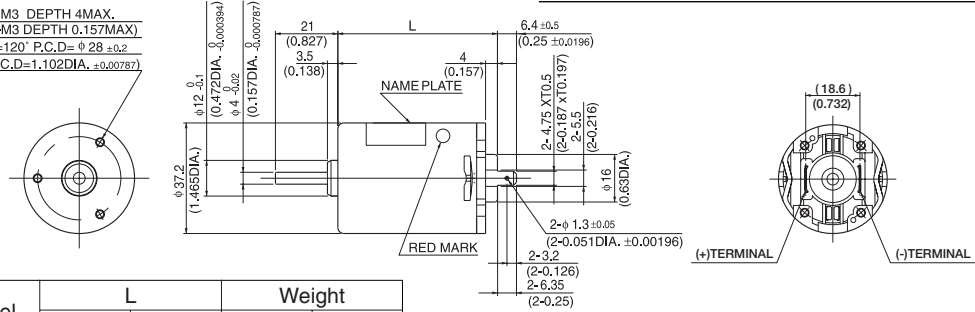

Model	L		Weight	
	(mm)	(inch)	g	lb
DME37SA DME37SB	45.7	1.8	130	0.28
DME37BA DME37BB	53.7	2.11	180	0.40
DME37KA DME37KB	58.7	2.31	210	0.46
DME37JB	63.7	2.51	240	0.53

● CURRENT, SPEED-TORQUE CURVE

DME37SA, DME37SB

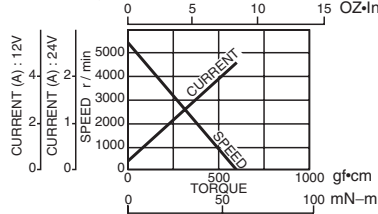

DME37BA, DME37BB

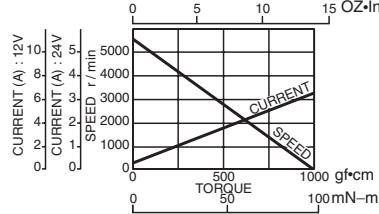

DME37KA, DME37KB

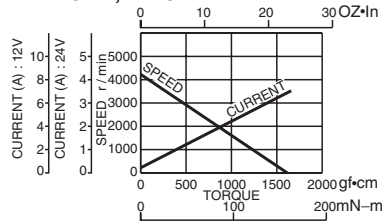

DME37JB

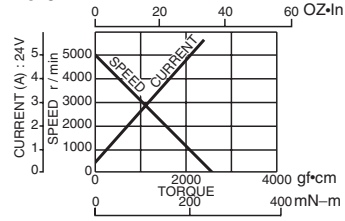

● CONNECTION

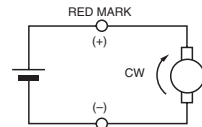

● STANDARD SPECIFICATIONS

Model	Rated					No load		Stall torque		
	Output W	Voltage V	Torque		Current A	Speed r/min	Current A	Speed r/min	mN·m	
			mN·m	oz·in					mN·m	oz·in
DME37SA	4.6	12	10	1.42	0.78	4500	0.26	5500	54	7.64
DME37SB	4.6	24	10	1.42	0.37	4500	0.12	5500	54	7.64
DME37BA	7.2	12	15	2.12	1.01	4700	0.25	5500	98	13.88
DME37BB	7.2	24	15	2.12	0.53	4700	0.13	5500	98	13.88
DME37KA	9.2	12	24.5	3.5	1.20	3600	0.27	4300	160	22.66
DME37KB	9.2	24	24.5	3.5	0.60	3600	0.14	4300	160	22.66
DME37JB	17.2	24	39	5.52	1.07	4200	0.18	5000	240	34

● REVOLUTION SENSOR MAGNET TYPE

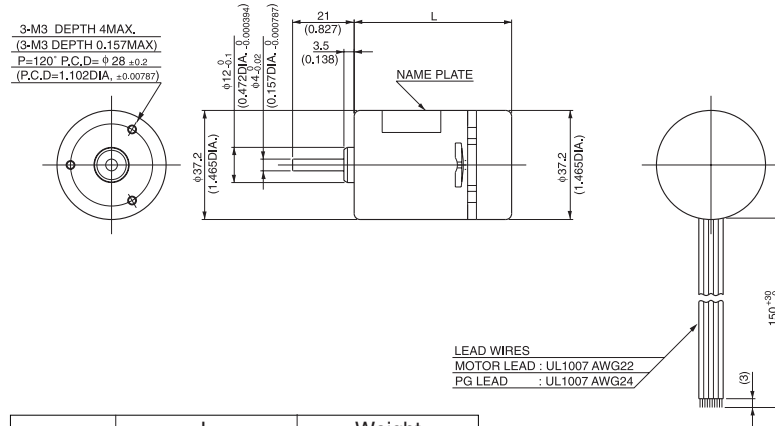

Model	L		Weight	
	mm	inch	g	lb
DME37SMA	53.7	2.11	140	0.31
DME37SMB				
DME37BMA	61.7	2.43	190	0.42
DME37BMB				
DME37KMA	66.7	2.63	220	0.49
DME37KMB				
DME37JMB	71.7	2.82	250	0.55

● CONNECTION OF REVOLUTION SENSOR

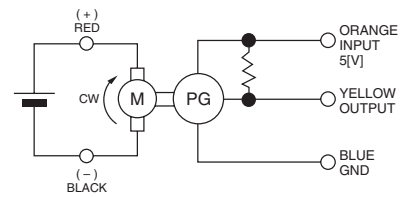

● SPECIFICATION OF REVOLUTION SENSOR ARE SHOWN ON PAGE 8.

WITH GEARBOX
50G

● DIMENSIONS Unit mm(inch)

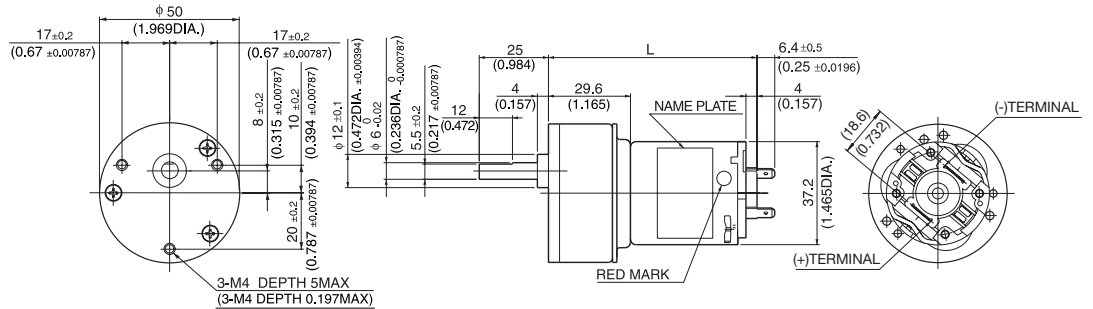

50G

Model	L		Weight	
	(mm)	(inch)	g	lb
DME37S50G	75.3	2.96	280	0.62
DME37B50G	83.3	3.28	330	0.73
DME37K50G	88.3	3.48	360	0.79

● with 50G TYPE GEARBOX

Model	Gear ratio		9	18	*27	*36	*54	*72	96	144	192	256
	Rated speed	r/min	500	250	166	125	83.3	62.5	46.8	31.2	24.5	19.1
DME37S50G ☆	Rated torque	N-m	0.072	0.14	0.19	0.25	0.38	0.51	0.62	0.93	0.98	0.98
		oz-in	10.14	19.44	26.39	36.11	54.16	72.21	87.49	130.54	138.87	138.87
DME37B50G ☆	Rated speed	r/min	522	261	174	130	87	65.2	48.9	34.2	26.4	20.2
		Rated torque	N-m	0.11	0.22	0.28	0.38	0.58	0.76	0.92	0.98	0.98
DME37K50G ☆	Rated speed	r/min	400	200	133	100	66.6	52.3	40.1	27.8	21.2	16.1
		Permission torque	N-m	0.17	0.35	0.48	0.63	0.96	0.98	0.98	0.98	0.98
DME37K50G ☆	Permission torque	oz-in	25	50	68.05	90.27	136.09	138.87	138.87	138.87	138.87	138.87

DME37

MODEL CODE	VOLTAGE	OUTPUT	CURRENT
SA	12V	4.6W	0.78A
SB	24V	4.6W	0.37A
BA	12V	7.2W	1.01A
BB	24V	7.2W	0.53A
KA	12V	9.2W	1.20A
KB	24V	9.2W	0.60A
JB	24V	17.2W	1.07A

WITH GEARBOX
6DG



6DG

● DIMENSIONS Unit mm(inch)

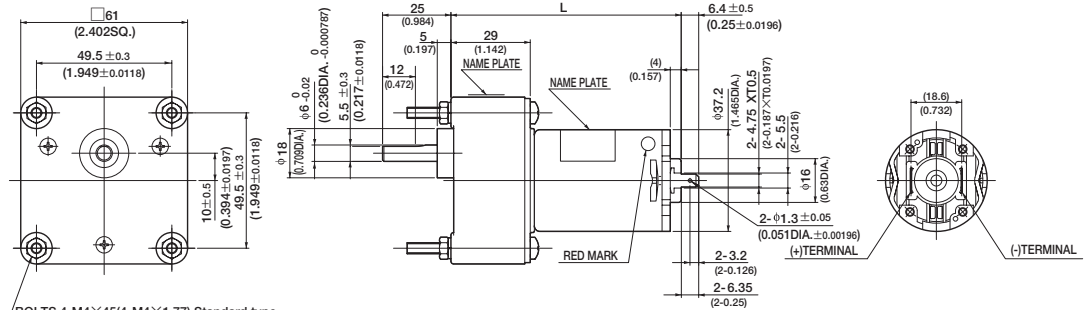

BOLTS 4-M4×45(4-M4×1.77) Standard type
4-M4 DEPTH 6MAX.(4-M4 DEPTH 0.236MAX.) Order made type

NOTE:
6DG gearbox are available with either 4.5mm diameter mounting holes or M4 x 6mm tapped holes.
● Gearboxes with 4.5mm diameter mounting holes are available from stock. When ordering, please write the motor model and gearbox model numbers separately, as in the following example:
DME37B6HPB (Pinion shaft motor)
6DG (Gearbox)
● Gearboxes with M4 x 6mm tapped mounting holes are available on request. When ordering, please write the combine motor and gearbox model, as in the following example : DME37B6H

Model	L		Weight	
	(mm)	(inch)	g	lb
DME37S6H	76.2	3.0	430	0.95
DME37B6H	84.2	3.31	480	1.06
DME37K6H	89.2	3.51	510	1.12

● with 6DG TYPE GEARBOX MOTOR MODEL DME37S6HP☆, DME37B6HP☆, DME37K6HP☆ & GEARBOX MODEL 6DG□

Model	Gear ratio		5	12.5	15	*25	*30	*50	*75	*100	150	180	250
	DME37S6HP☆ & 6DG□	Rated speed	r/min	900	360	300	180	150	90	60	45	30	25.8
Rated torque		N·m	0.039	0.098	0.12	0.18	0.22	0.35	0.53	0.72	0.96	0.98	0.98
		oz·in	5.55	13.89	16.66	25.00	30.55	49.99	74.99	101.38	136.09	138.87	138.87
DME37B6HP☆ & 6DG□	Rated speed	r/min	940	376	313	188	156	94	62.6	47.7	33	28	20.7
	Rated torque	N·m	0.059	0.15	0.18	0.26	0.32	0.53	0.8	0.98	0.98	0.98	0.98
		oz·in	8.33	20.83	25.00	37.50	45.83	74.99	113.87	138.87	138.87	138.87	138.87
DME37K6HP☆ & 6DG□	Rated speed	r/min	720	288	240	144	120	72	50.5	39.1	26.7	22.5	16.5
	Permission torque	N·m	0.098	0.24	0.29	0.44	0.53	0.89	0.98	0.98	0.98	0.98	0.98
		oz·in	13.89	34.72	41.66	62.49	74.99	126.37	138.87	138.87	138.87	138.87	138.87
Model	Gear ratio		300	450	*500	*750	*900	*1800					
	Rated speed	r/min	16.6	11.4	10.3	7	5.9	3					
DME37S6HP☆ & 6DG□	Rated torque	N·m	0.98	0.98	0.98	0.98	0.98	0.98					
		oz·in	138.87	138.87	138.87	138.87	138.87	138.87					
DME37B6HP☆ & 6DG□	Rated speed	r/min	17.4	11.8	10.6	7.1	6	3					
	Rated torque	N·m	0.98	0.98	0.98	0.98	0.98	0.98					
		oz·in	138.87	138.87	138.87	138.87	138.87	138.87					
DME37K6HP☆ & 6DG□	Rated speed	r/min	13.8	9.3	8.4	5.6	4.7	2.3					
	Permission torque	N·m	0.98	0.98	0.98	0.98	0.98	0.98					
		oz·in	138.87	138.87	138.87	138.87	138.87	138.87					

NOTE 1: Enter the required reduction ratio in the □.
2: *Rotation of gearbox shaft is in reverse of rotation of motor.
3: Enter the required voltage A or B in the ☆.

WITH GEARBOX 6DGF



6DGF

● DIMENSIONS Unit mm(inch) DME37B6DGF

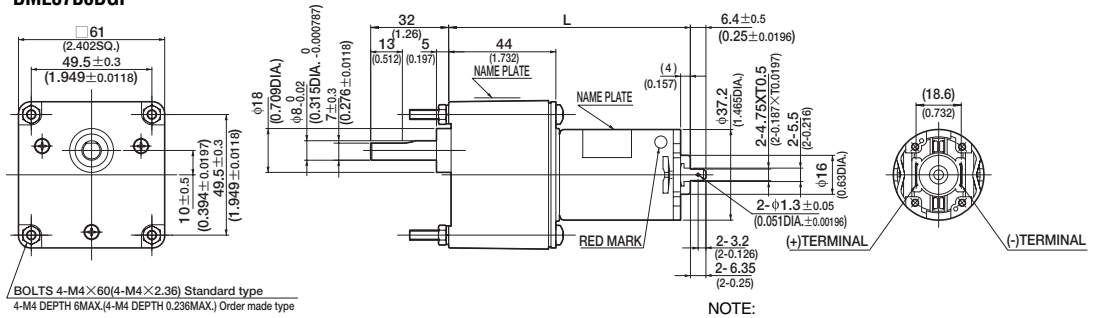

(WEIGHT 0.53kg 1.17lb)

NOTE:

- 6DGF gearbox are available with either 4.5mm diameter mounting holes or M4 x 6mm tapped holes.
- Gearboxes with 4.5mm diameter mounting holes are available from stock. When ordering, please write the motor model and gearbox model numbers separately, as in the following example:
DME37B6HF (Pinion shaft motor)
6DGF (Gearbox)
- Gearboxes with M4 x 6mm tapped mounting holes are available on request. When ordering, please write the combine motor and gearbox model, as in the following example : **DME37B6HF** **B**

● with 6DGF TYPE GEARBOX MOTOR MODEL DME37B6HFP☆, DME37K6HFP☆, DME37J6HFPB & GEARBOX MODEL 6DGF

Model	Gear ratio		5	*12.5	*15	*25	*30	50	75	100	150	180
	Rated speed	r/min	940	376	313	188	156	94	62.6	47	31.3	26.1
DME37B6HFP ☆ & 6DGF	Rated torque	N-m	0.059	0.13	0.16	0.26	0.32	0.48	0.73	0.96	1.4	1.7
		oz-in	8.33	18.05	22.22	37.50	45.83	68.05	102.76	136.09	194.42	236.08
DME37K6HFP ☆	Rated speed	r/min	720	288	240	144	120	72	48	36	24	20.6
	Permission torque	N-m	0.098	0.21	0.26	0.44	0.53	0.8	1.1	1.5	2.3	2.4
		oz-in	13.89	30.55	37.5	62.49	74.99	113.88	166.65	222.19	333.29	347.18
DME37J6HFPB & 6DGF	Rated speed	r/min	840	336	280	168	140	84	56	42.3	29.9	25.4
	Permission torque	N-m	0.15	0.35	0.42	0.71	0.85	1.2	1.8	2.4	2.4	2.4
		oz-in	22.22	49.99	59.71	101.38	120.82	180.53	263.86	347.18	347.18	347.18

- NOTE
- 1: Enter the required reduction ratio in the □.
 - 2: *Rotation of gearbox shaft is in reverse of rotation of motor.
 - 3: Enter the required voltage A or B in the ☆.

WITH GEARBOX 8DG



8DG

● DIMENSIONS Unit mm(inch) DME37B8DG

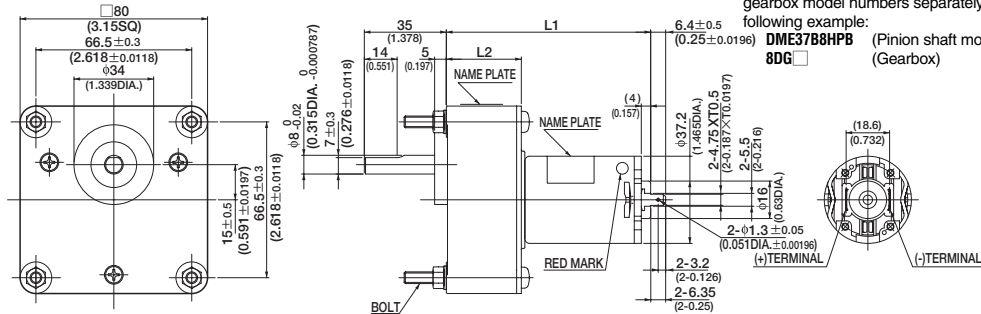

Model	GEAR RATIO	L1		L2		BOLT		WEIGHT	
		(mm)	(inch)	(mm)	(inch)	(mm)	(inch)	g	lb
DME37B8HP	30~150	87.2	3.433	32	1.26	M5X50	M5X1.969	680	1.5
	250~1800	97.2	3.826	42	1.654	M5X60	M5X2.362	780	1.72
DME37K8HP	30~150	92.2	3.63	32	1.26	M5X50	M5X1.969	710	1.57
	250~1800	102.2	4.024	42	1.654	M5X60	M5X2.362	810	1.79
DME37J8HP	30~150	97.2	3.827	32	1.26	M5X50	M5X1.969	740	1.63
	250~1800	107.2	4.22	42	1.654	M5X60	M5X2.362	840	1.85

● with 8DG TYPE GEARBOX MOTOR MODEL DME37B8HP☆, DME37K8HP☆, DME37J8HPB & GEARBOX MODEL 8DG□

Model	Gear ratio		*30	*50	*75	*100	*150	250	300	*500	*750	*1800	
			DME37B8HP☆ & 8DG□	Rated speed	r/min	156	94	62.6	47	31.3	18.8	15.6	9.5
DME37K8HP☆ & 8DG□	Rated torque	N-m	0.32	0.53	0.8	1.1	1.6	2.4	2.8	3.9	3.9	3.9	
		oz-in	45.83	74.99	113.87	152.76	222.19	333.29	402.73	555.49	555.49	555.49	
DME37J8HPB & 8DG□	Permission torque	r/min	120	72	48	36	24	14.4	12.4	7.8	5.4	2.3	
		N-m	0.53	0.89	1.2	1.7	2.6	3.9	3.9	3.9	3.9	3.9	
DME37J8HPB & 8DG□	Permission torque	oz-in	74.99	126.37	180.53	249.97	374.95	555.49	555.49	555.49	555.49	555.49	
		Rated speed	r/min	140	84	56	42	28.4	18	15.3	9.4	6.4	2.7
		N-m	0.85	1.3	2.1	2.8	3.9	3.9	3.9	3.9	3.9	3.9	
DME37J8HPB & 8DG□	Permission torque	oz-in	120.82	194.42	305.52	402.73	555.49	555.49	555.49	555.49	555.49	555.49	

WITH GEARBOX 8DGF



8DGF

● DIMENSIONS Unit mm(inch) DME37J8DGF

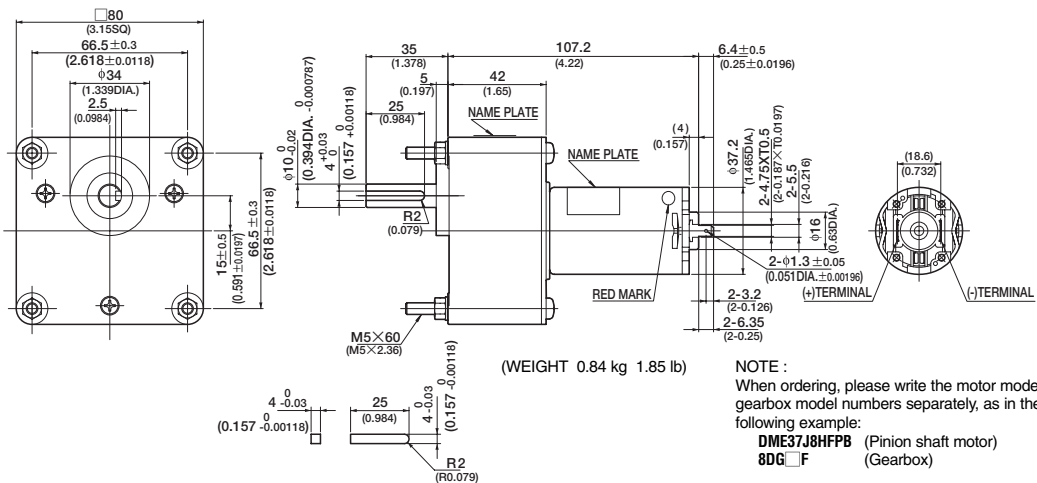

● with 8DGF TYPE GEARBOX MOTOR MODEL DME37J8HFPB & GEARBOX MODEL 8DGF□

Model	Gear ratio		*25	*30	50	75	100	180
			DME37J8HFPB & 8DGF□	Rated speed	r/min	168	140	84
DME37J8HFPB & 8DGF□	Permission torque	N-m	0.71	0.85	1.3	1.8	2.5	4.6
		oz-in	101.38	120.82	194.42	263.86	361.07	652.7

NOTE
1: Enter the required reduction ratio in the □.
2: *Rotation of gearbox shaft is in reverse of rotation of motor.
3: Enter the required voltage A or B in the ☆.

DME44

MODEL CODE	VOLTAGE	OUTPUT	CURRENT
SA	12V	9.2W	1.31A
SB	24V	9.2W	0.65A
BB	24V	14.8W	0.94A



● DIMENSIONS Unit mm(inch)

DME44SA, DME44SB

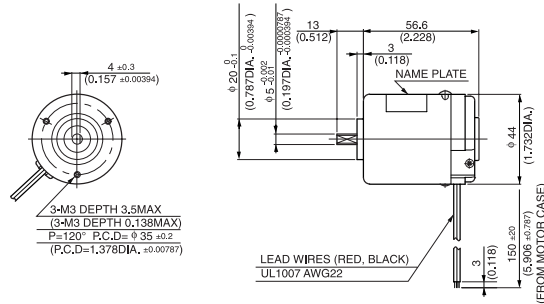

DME44BA, DME44BB

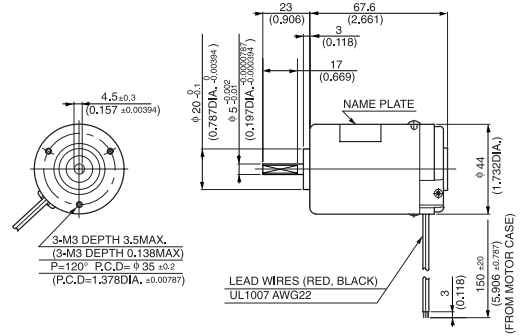

● CURRENT, SPEED-TORQUE CURVE

DME44SA, DME44SB

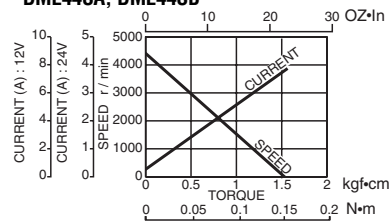

DME44BA, DME44BB

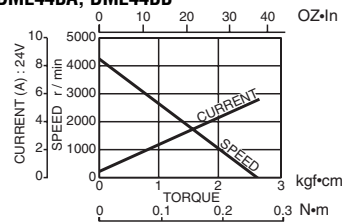

● CONNECTION

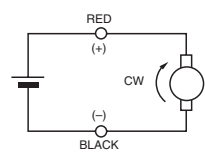

● STANDARD SPECIFICATIONS

Model	Rated					No load		Stall torque		Weight		
	Output W	Voltage V	Torque		Current A	Speed r/min	Current A	Speed r/min	mN-m	oz-in	Weight	
			mN-m	oz-in							g	lb
DME44SA	9.2	12	24	3.47	1.31	3600	0.31	4300	150	22.22	300	0.66
DME44SB	9.2	24	24	3.47	0.65	3600	0.15	4300	150	22.22	300	0.66
DME44BB	14.8	24	39	5.55	0.94	3600	0.16	4300	250	36.11	400	0.88

● REVOLUTION SENSOR MAGNET TYPE

DME44SMA, DME44SMB

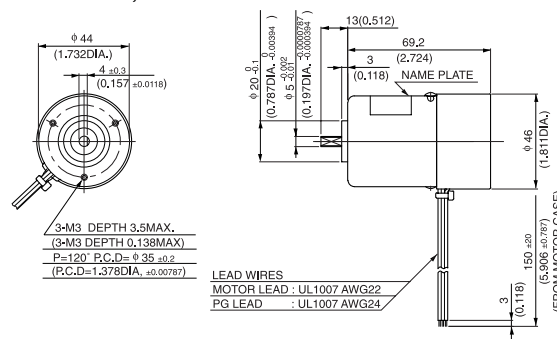

(WEIGHT 400 g 0.88 lb)

● CONNECTION OF REVOLUTION SENSOR

DME44SMA, DME44SMB, DME44BMB

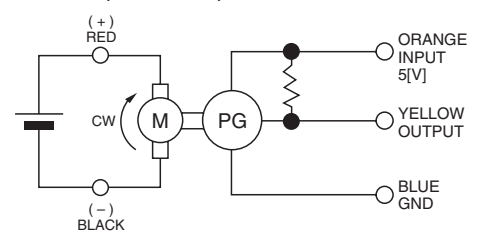

DME44BMB

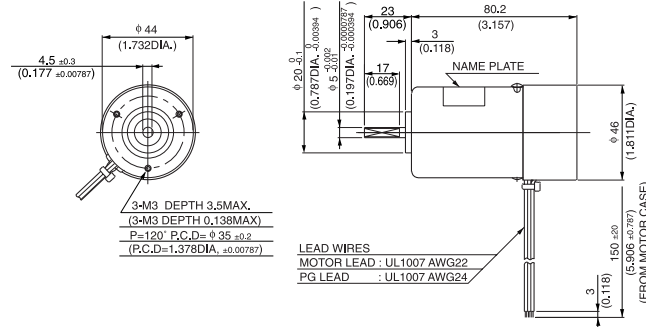

(WEIGHT 500 g 1.1lb)

● SPECIFICATION OF REVOLUTION SENSOR ARE SHOWN ON PAGE 8.

DME44

MODEL CODE	VOLTAGE	OUTPUT	CURRENT
SA	12V	9.2W	1.31A
SB	24V	9.2W	0.65A
BB	24V	14.8W	0.94A

WITH GEARBOX 50G



50G

● DIMENSIONS Unit mm(inch) DME44S50G

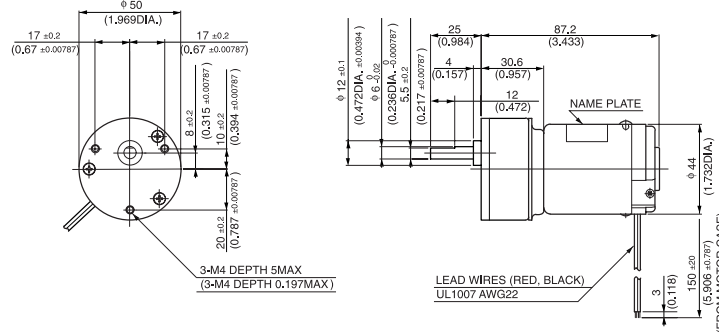

(WEIGHT 400 g 0.88lb)

● with 50G TYPE GEARBOX

Model	Gear ratio		9	18	*27	*36	*54	*72
	Rated speed	r/min	400	200	133	100	66.6	52.3
DME44S50G <input type="checkbox"/> ☆	Rated torque	N-m	0.18	0.35	0.48	0.64	0.96	0.98
		oz-in	25.00	49.99	68.05	90.27	136.09	138.87

WITH GEARBOX 6DG



6DG

● DIMENSIONS Unit mm(inch) DME44S6DG

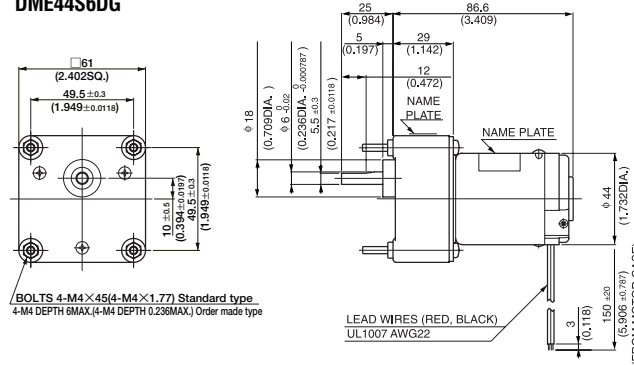

(WEIGHT 600 g 1.32 lb)

NOTE:

6DG gearbox are available with either 4.5mm diameter mounting holes or M4 x 6mm tapped holes.

● Gearboxes with 4.5mm diameter mounting holes are available from stock. When ordering, please write the motor model and gearbox model numbers separately, as in the following example:

DME44S6HPB (Pinion shaft motor)
6DG (Gearbox)

● Gearboxes with M4 x 6mm tapped mounting holes are available on request. When ordering, please write the combine motor and gearbox model, as in the following example : DME44S6H B

● with 6DG TYPE GEARBOX MOTOR MODEL DME44S6HP ☆ & GEARBOX MODEL 6DG

Model	Gear ratio		5	12.5	15	*25	*30	*50	*75	*100	150	180	250
	Rated speed	r/min	720	288	240	144	120	72	50.5	39.1	26.7	22.5	16.5
DME44S6HP ☆ & 6DG <input type="checkbox"/>	Rated torque	N-m	0.1	0.25	0.29	0.44	0.53	0.89	0.98	0.98	0.98	0.98	0.98
		oz-in	13.89	34.72	41.66	62.49	74.99	126.37	138.87	138.87	138.87	138.87	138.87

Model	Gear ratio		300	450	*500	*750	*900	*1800
	Rated speed	r/min	13.8	9.3	8.4	5.6	4.7	2.3
DME44S6HP ☆ & 6DG <input type="checkbox"/>	Rated torque	N-m	0.98	0.98	0.98	0.98	0.98	0.98
		oz-in	138.87	138.87	138.87	138.87	138.87	138.87

NOTE
 1: Enter the required reduction ratio in the .
 2: *Rotation of gearbox shaft is in reverse of rotation of motor.
 3: Enter the required voltage A or B in the ☆.

WITH GEARBOX 6DGF



6DGF

●DIMENSIONS Unit mm(inch) DME44S6DGF

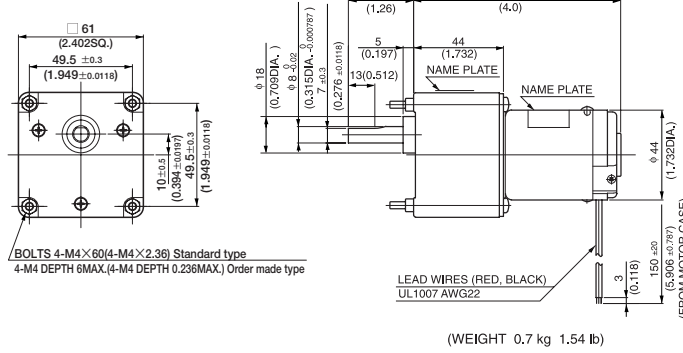

NOTE:
6DGF gearbox are available with either 4.5mm diameter mounting holes or M4 x 6mm tapped holes.
●Gearboxes with 4.5mm diameter mounting holes are available from stock. When ordering, please write the motor model and gearbox model numbers separately, as in the following example:
DME44B6HFPB (Pinion shaft motor)
6DG□F (Gearbox)
●Gearboxes with M4 x 6mm tapped mounting holes are available on request. When ordering, please write the combine motor and gearbox model, as in the following example : DME44B6HF□B

DME44B6DGF

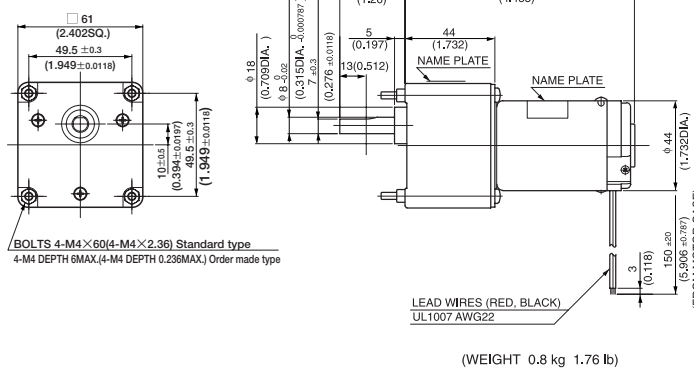

●with 6DGF TYPE GEARBOX MOTOR MODEL DME44S6HFP☆, DME44B6HFPB & GEARBOX MODEL 6DG□F

Model	Gear ratio	Gear ratio										
		5	*12.5	*15	*25	*30	50	75	100	150	180	
DME44S6HFP☆ & 6DG□F	Rated speed	r/min	720	288	240	144	120	72	48	36	24	20.6
	Rated torque	N-m	0.1	0.22	0.27	0.44	0.53	0.80	1.2	1.6	2.4	2.4
oz-in		13.89	30.55	37.50	62.49	74.99	113.87	166.65	222.19	333.29	347.18	
DME44B6HFPB & 6DG□F	Rated speed	r/min	720	288	240	144	120	72	48	36.3	25.7	21.8
	Rated torque	N-m	0.16	0.35	0.43	0.72	0.85	1.3	1.9	2.4	2.4	2.4
oz-in		22.22	49.99	59.71	101.38	120.82	180.53	263.86	347.18	347.18	347.18	

WITH GEARBOX 8DG



8DG

●DIMENSIONS Unit mm(inch) DME44S8DG

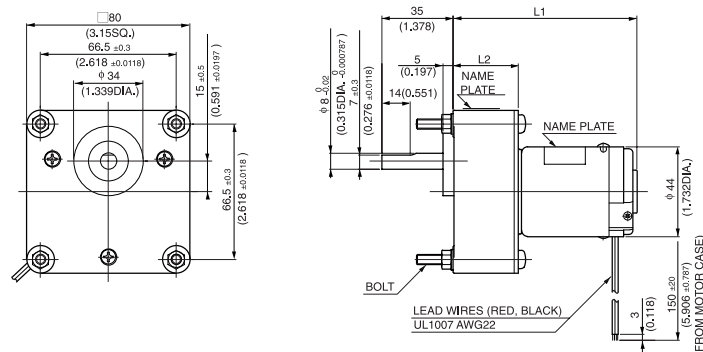

NOTE :
When ordering, please write the motor model and gearbox model numbers separately, as in the following example:
DME44B8HPB (Pinion shaft motor)
8DG□ (Gearbox)

GEAR RATIO	L1		L2		BOLT		WEIGHT	
	(mm)	(inch)	(mm)	(inch)	(mm)	(inch)	kg	lb
30~150	90.1	3.547	32	1.26	M5X50	M5X1.969	0.8	1.76
250~1800	100.1	3.941	42	1.654	M5X60	M5X2.362	0.9	1.98

NOTE 1: Enter the required reduction ratio in the □.
2: *Rotation of gearbox shaft is in reverse of rotation of motor.
3: Enter the required voltage A or B in the ☆.

DME44

WITH GEARBOX
8DG

MODEL CODE	VOLTAGE	OUTPUT	CURRENT
SA	12V	9.2W	1.31A
SB	24V	9.2W	0.65A
BB	24V	14.8W	0.94A

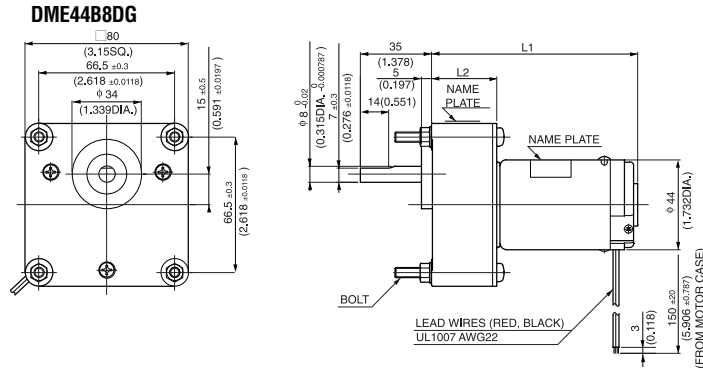

GEAR RATIO	L1		L2		BOLT		WEIGHT	
	(mm)	(inch)	(mm)	(inch)	(mm)	(inch)	kg	lb
30~150	101.1	3.98	32	1.26	M5X50	M5X1.969	0.9	1.98
250~1800	111.1	4.374	42	1.654	M5X60	M5X2.362	1.0	2.2

● with 8DG TYPE GEARBOX MOTOR MODEL **DME44S8HP**☆, **DME44B8HPB** & GEARBOX MODEL **8DG**□

Model	Gear ratio		*30	*50	*75	*90	*100	*150	250
	DME44S8HP ☆ & 8DG □	Rated speed	r/min	120	72	48	40	36	24
Rated torque		N·m	0.53	0.89	1.3	1.6	1.8	2.7	3.9
	oz·in	74.99	126.37	180.53	222.19	249.97	374.95	555.49	
DME44B8HPB & 8DG □	Rated speed	r/min	120	72	48	40	36	24.4	15.5
	Rated torque	N·m	0.85	1.4	2.1	2.5	2.8	3.9	3.9
oz·in		120.82	194.42	305.52	361.07	402.73	555.49	555.49	

Model	Gear ratio		300	*500	*750	*1800
	Rated speed	r/min	12.4	7.8	5.4	2.3
DME44S8HP ☆ & 8DG □	Rated torque	N·m	3.9	3.9	3.9	3.9
		oz·in	555.49	555.49	555.49	555.49
DME44B8HPB & 8DG □	Rated speed	r/min	13.1	8	5.5	2.3
	Rated torque	N·m	3.9	3.9	3.9	3.9
oz·in		555.49	555.49	555.49	555.49	

WITH GEARBOX
8DGF



8DGF

● DIMENSIONS Unit mm(inch)
DME44B8DGF

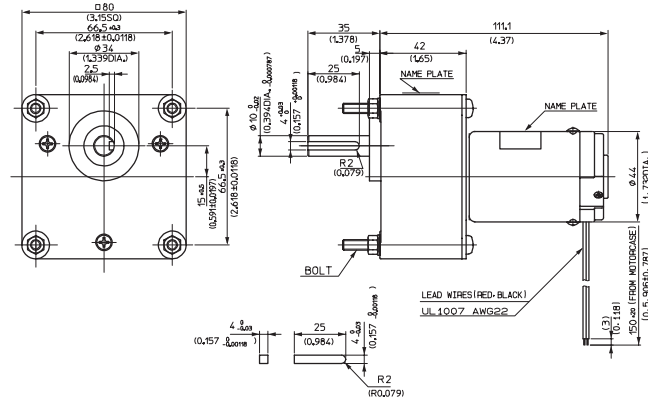

NOTE :
When ordering, please write the motor model and gearbox model numbers separately, as in the following example:
DME44B8HFPB (Pinion shaft motor)
8DGF (Gearbox)

GEAR RATIO	BOLT		WEIGHT	
	(mm)	(inch)	kg	lb
25~150	M5X60	M5X2.36	1.0	2.2

● with 8DGF TYPE GEARBOX MOTOR MODEL **DME44B8HFPB** & GEARBOX MODEL **8DGF**□F

Model	Gear ratio		*25	*30	50	75	100	150
	DME44B8HPB & 8DGF □F	Rated speed	r/min	144	120	72	48	36
Rated torque		N·m	0.71	0.85	1.3	1.9	2.5	3.8
	oz·in	101.38	120.82	194.42	263.86	361.07	541.60	

NOTE
1: Enter the required reduction ratio in the □.
2: *Rotation of gearbox shaft is in reverse of rotation of motor.
3: Enter the required voltage A or B in the ☆.

DME60

MODEL CODE	VOLTAGE	OUTPUT	CURRENT
SA	12V	13W	2.07A
SB	24V	13W	1A
BB	24V	26W	1.79A



● DIMENSIONS Unit mm(inch)

DME60SA, DME60SB

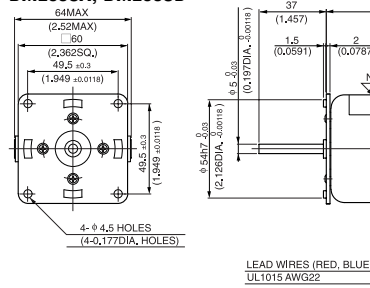

DME60BB

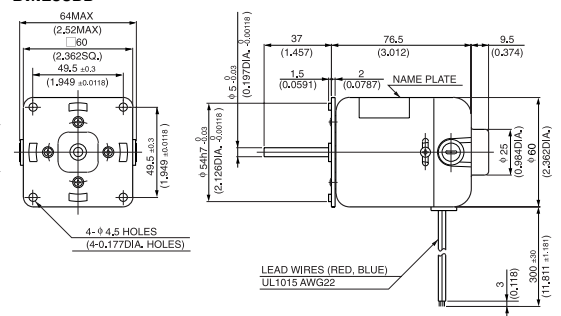

● CURRENT, SPEED-TORQUE CURVE

DME60SA, DME60SB

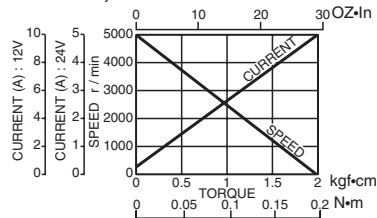

DME60BB

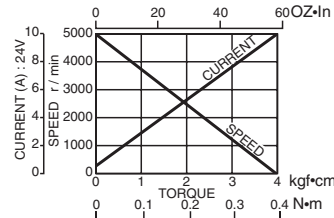

● CONNECTION

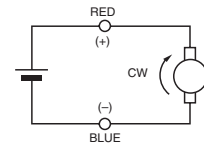

● STANDARD SPECIFICATIONS

Model	Rated					No load		Stall torque		Weight		
	Output W	Voltage V	Torque		Current A	Speed r/min	Current A	Speed r/min	mN-m	oz-in	Weight	
			mN-m	oz-in							g	lb
DME60SA	13	12	29	4.17	2.07	4300	0.6	5000	196	16.66	600	1.32
DME60SB	13	24	29	4.17	1.00	4300	0.33	5000	196	16.66	600	1.32
DME60BB	26	24	59	8.33	1.79	4300	0.42	5000	392	55.55	650	1.43

WITH GEARBOX 6DG

● DIMENSIONS Unit mm(inch)

DME60S6DG

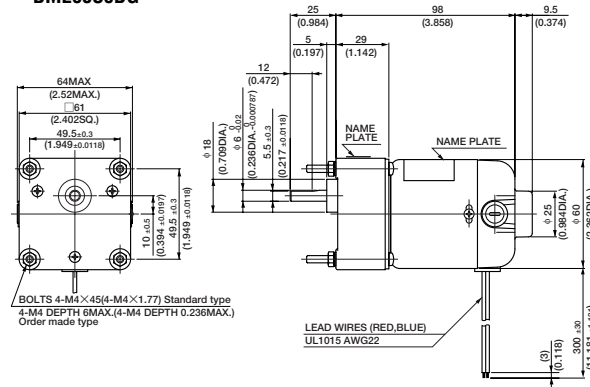

NOTE:

6DG gearbox are available with either 4.5mm diameter mounting holes or M4 x 6mm tapped holes.

● Gearboxes with 4.5mm diameter mounting holes are available from stock. When ordering, please write the motor model and gearbox model numbers separately, as in the following example:

DME60S6HPB (Pinion shaft motor)
6DG (Gearbox)

● Gearboxes with M4 x 6mm tapped mounting holes are available on request. When ordering, please write the combine motor and gearbox model, as in the following example: DME60S6H B

● with 6DG TYPE GEARBOX MOTOR MODEL DME60S6HP☆ & GEARBOX MODEL 6DG □

Model	Gear ratio												
	5	12.5	15	*25	*30	*50	*75	*100	150	180	250		
DME60S6HP☆ & 6DG □	Rated speed	r/min	860	344	286	172	143	87.2	60.9	46.8	35	30	21
	Rated torque	N-m	0.12	0.29	0.35	0.53	0.64	0.98	0.98	0.98	0.98	0.98	0.98
oz-in		16.66	41.66	49.99	74.99	90.27	138.87	138.87	138.87	138.87	138.87	138.87	138.87
Model	Gear ratio												
	300	450	*500	*750	*900	*1800							
DME60S6HP☆ & 6DG □	Rated speed	r/min	17	12	9.8	6.6	5.5	2.7					
	Rated torque	N-m	0.98	0.98	0.98	0.98	0.98	0.98					
oz-in		138.87	138.87	138.87	138.87	138.87	138.87						

NOTE 1: Enter the required reduction ratio in the □.
2: *Rotation of gearbox shaft is in reverse of rotation of motor.
3: Enter the required voltage A or B in the ☆.

DME60

WITH GEARBOX 6DGF



6DGF

● DIMENSIONS Unit mm(inch) DME60S6DGF

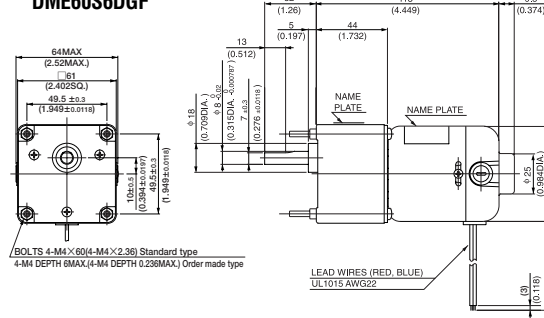

(WEIGHT 1.0 kg 2.2 lb)

MODEL CODE	VOLTAGE	OUTPUT	CURRENT
SA	12V	13W	2.07A
SB	24V	13W	1A
BB	24V	26W	1.79A

DME60B6DGF

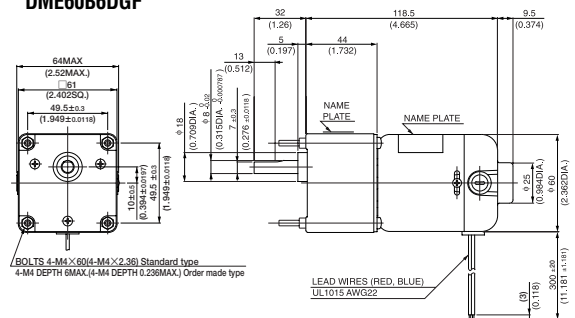

(WEIGHT 1.05 kg 2.3 lb)

NOTE:

6DGF gearbox are available with either 4.5mm diameter mounting holes or M4 x 6mm tapped holes.

● Gearboxes with 4.5mm diameter mounting holes are available from stock. When ordering, please write the motor model and gearbox model numbers separately, as in the following example:

DME60S6HFPB (Pinion shaft motor)

6DG□F (Gearbox)

● Gearboxes with M4 x 6mm tapped mounting holes are available on request. When ordering, please write the combine motor and gearbox model, as in the following example : DME60S6HF□B

● with 6DGF TYPE GEARBOX MOTOR MODEL DME60S6HFP☆, DME60B6HFPB & GEARBOX MODEL 6DG□F

Model	Gear ratio		5	*12.5	*15	*25	*30	50	75	100	150	180
	Rated speed	r/min	860	344	286	172	143	86	57.3	43	29.4	25
DME60S6HFP☆ & 6DG□	Rated torque	N·m	0.12	0.27	0.32	0.53	0.64	0.96	1.4	1.9	2.4	2.4
		oz·in	16.66	37.50	45.83	74.99	48.61	136.09	194.42	263.86	347.18	347.18
DME60B6HFPB & 6DG□	Rated speed	r/min	860	344	286	172	143	86	58.7	45	31.3	26.4
		Rated torque	N·m	0.24	0.53	0.64	1.0	1.3	1.9	2.4	2.4	2.4
		oz·in	33.33	74.99	90.27	152.76	180.53	263.86	347.18	347.18	347.18	347.18

WITH GEARBOX 8DG



8DG

● DIMENSIONS Unit mm(inch) DME60S8DG

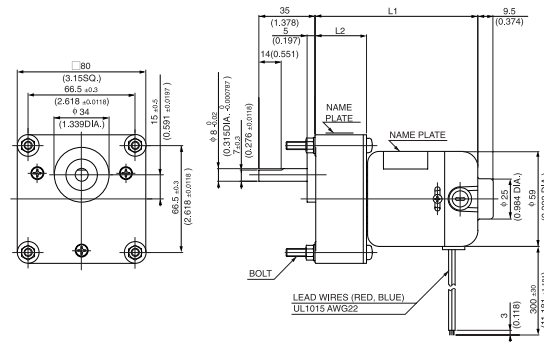

DME60B8DG

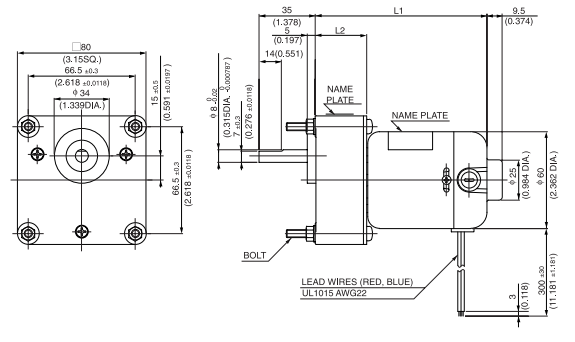

NOTE :

When ordering, please write the motor model and gearbox model numbers separately, as in the following example:

DME60B8HPB (Pinion shaft motor)

8DG□ (Gearbox)

GEAR RATIO	L1		L2		BOLT		WEIGHT	
	(mm)	(inch)	(mm)	(inch)	(mm)	(inch)	kg	lb
30~150	101	3.98	32	1.26	M5X50	M5X1.969	1.1	2.4
250~1800	111	4.37	42	1.654	M5X60	M5X2.362	1.2	2.6

GEAR RATIO	L1		L2		BOLT		WEIGHT	
	(mm)	(inch)	(mm)	(inch)	(mm)	(inch)	kg	lb
30~150	106.5	4.193	32	1.26	M5X50	M5X1.969	1.15	2.5
250~1800	116.5	4.587	42	1.654	M5X60	M5X2.362	1.25	2.8

NOTE

- 1: Enter the required reduction ratio in the □.
- 2: *Rotation of gearbox shaft is in reverse of rotation of motor.
- 3: Enter the required voltage A or B in the ☆.

WITH GEARBOX
8DG

●with 8DG TYPE GEARBOX MOTOR MODEL **DME60S8HP**☆, **DME60B8HPB** & GEARBOX MODEL **8DG**□

Model	Gear ratio		*30	*50	*75	*100	*150	250	300	*500	*750	*1800
	Rated speed	r/min	143	86	57.3	43	28.6	17.7	15.1	9.3	6.4	2.7
DME60S8HP ☆ & 8DG □	Rated torque	N-m	0.64	1.0	1.6	2.1	3.2	3.9	3.9	3.9	3.9	3.9
		oz-in	90.27	152.76	222.19	305.52	458.28	555.49	555.49	555.49	555.49	555.49
DME60B8HPB & 8DG □	Rated speed	r/min	143	86	57.3	43.6	30.5	18.8	15.8	9.7	6.5	2.7
	Rated torque	N-m	1.3	2.1	3.2	3.9	3.9	3.9	3.9	3.9	3.9	3.9
		oz-in	180.53	305.52	458.28	555.49	555.49	555.49	555.49	555.49	555.49	555.49

WITH GEARBOX
8DGF



8DGF

●DIMENSIONS Unit mm(inch)
DME60S8DGF

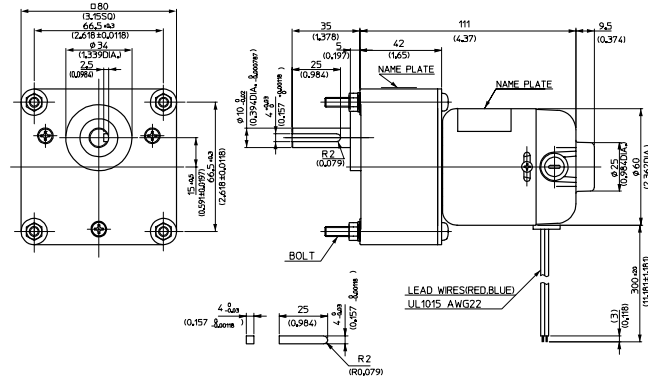

NOTE :

When ordering, please write the motor model and gearbox model numbers separately, as in the following example:

DME60B8HFPB (Pinion shaft motor)
8DGF (Gearbox)

GEAR RATIO	BOLT		WEIGHT	
	(mm)	(inch)	kg	lb
25~150	M5X60	M5X2.36	1.20	2.6

DME60B8DGF

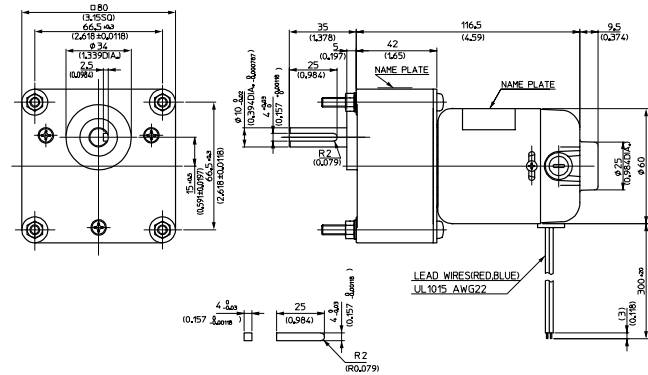

GEAR RATIO	BOLT		WEIGHT	
	(mm)	(inch)	kg	lb
25~150	M5X60	M5X2.36	1.25	2.8

●with 8DGF TYPE GEARBOX MOTOR MODEL **DME60S8HFP**☆, **DME60B8HFPB** & GEARBOX MODEL **8DGF**□F

Model	Gear ratio		*25	*30	50	75	100	150
	Rated speed	r/min	172	143	86	57.3	43	28.6
DME60S8HFP ☆ & 8DGF □F	Rated torque	N-m	0.53	0.64	0.96	1.4	1.9	2.9
		oz-in	74.99	90.27	152.76	194.42	263.86	402.73
DME60B8HFPB & 8DGF □F	Rated speed	r/min	172	143	86	57.3	43	28.6
	Rated torque	N-m	1.0	1.3	1.9	2.9	3.8	5.8
		oz-in	152.76	180.53	305.52	402.73	541.60	819.34

NOTE 1: Enter the required reduction ratio in the □.
2: *Rotation of gearbox shaft is in reverse of rotation of motor.
3: Enter the required voltage A or B in the ☆.



www.nidec-servo.com

**NIDEC SERVO CORPORATION
INTERNATIONAL SALES OFFICE**

Osaki MT Building 2F, 5-9-11
Kita-Shinagawa, Shinagawa-ku, Tokyo, 141-0001
Tel: +81-(0)3-6756-5304 Fax: +81-(0)3-6702-0507

NIDEC SERVO AMERICA CORPORATION

2050 Center Ave. Suite 318
Fort Lee, NJ 07024
Tel: +1-(0) 201-585-0720
Fax: +1-(0) 201-585-0670

NIDEC SERVO EUROPE B.V.

PO Box 1099, 3840 BB Harderwijk
The Netherlands
Tel: +31-(0) 3414-27575
Fax: +31-(0) 3414-23388

PO Box 7084, Hook, Hampshire, RG27 9XL, UK

Tel: +44-(0) 1256-767712
Fax: +44-(0) 1256-767715

**NIDEC SERVO CORPORATION
SINGAPORE BRANCH**

No. 50, Kallang Avenue #05-01,
Noel Corporate Buildings, Singapore 339505
Tel: +65-(0) 6743-7655
Fax: +65-(0) 6842-7839

NIDEC SERVO (HONG KONG) CO., LIMITED

Unit 1008-09, Saxon Tower, 7 Cheung Shun Street,
Lai Chi Kok, Kowloon, HONG KONG
Tel: +852-(0) 2314-0037
Fax: +852-(0) 2314-4768

**NIDEC SERVO (HONG KONG) CO., LIMITED
TAIWAN REPRESENTATIVE OFFICE**

Rm.1001, No.88, Sec.2,
Chung Shan N.Rd., Taipei 104 Taiwan
Nidec Taiwan Corporation.
FAX +852-(0) 3007-8924

WARNING

- Please do not exceed the specifications noted in this catalogue, otherwise there is a chance of electric shock, injury, or other damage.
- Any modifications made to this motor are beyond the limits of our guarantee. NIDEC SERVO cannot take responsibility for any customer modifications.
- Please ensure that a thorough evaluation has been done before using this motor in medical equipment or other devices related to human lives.
- Please ensure that a thorough evaluation has been done before using this motor in applications that have a serious effect on the public.

NOTE

- Figures in this catalogue are average measured values. Please request the product delivery specification when preparing a purchase specification.
- The dimensions, specifications, and components contained in this catalogue are subject to change without prior notice due to further product improvements.